

HOCKEY



CANADA

# REFEREE'S CASE BOOK/RULE COMBINATION

2010 - 2012



**Shared Respect**

players•coaches•officials•parents



# OFFICIAL CASE/RULE BOOK OF HOCKEY CANADA

The illustrations and text used in this publication are the exclusive copyright of Hockey Canada. Any reproduction of this publication in whole or in part without the written permission of Hockey Canada is strictly forbidden. The Referees' Case Book/Rule Combination is up to date as of May 2010 and will take effect at the beginning of the 2010-11 hockey season.

## INTRODUCTION TO THE CASE BOOK/RULE COMBINATION

This publication combines Hockey Canada Official Rule Book with situations (cases) related to the official rules. The "Case Book" entries are an important reference for referees, players, coaches and hockey executives. They provide guidance and information about how the playing rules are to be applied in various situations, and clarify misunderstandings related to the application of the rules.

### **FOREWORD**

The Combination Rule Book - Case Book is not a procedures manual. Approved procedures and techniques for officials can be found in the Hockey Canada Officiating Program Officiating Manual.

## MISSION STATEMENT

### **LEAD, DEVELOP AND PROMOTE POSITIVE HOCKEY EXPERIENCES**

© Copyright 2010 by Hockey Canada

All rights reserved. No part of this publication may be reproduced, stored in a retrieval system, or transmitted in any form or by any means, electronic, mechanical, or photocopying, recording or otherwise without prior permission of the copyright owner.

A copy of this document has been deposited at the Sport Information Resource Centre (SIRC), 116 Albert, Suite 400 Ottawa, Ontario K1P 5G3.

Printed in Canada

First published in Canada 1993 by Hockey Canada, 801 King Edward Avenue Drive, Suite N204, Ottawa, Ontario, K1N 6N5

ISBN 1-897355-20-3 8th edition (2010)  
Ce document est aussi disponible en français

## **FAIR PLAY INITIATIVE**

As a result of Hockey Canada's focus on fair play and improved communication between officials, coaches and players, Hockey Canada has implemented the following process:

"In all games, the officials shall approach each bench and meet the Coaches. This process should not take more than 15 seconds and will be completed prior to the game, at the end of the pre-game warm-up. Officials are also encouraged to shake hands with the Captains where possible".

This process is supported by the Coaching Program, Officiating Program and Hockey Canada's Board of Directors.

## **FAIR PLAY ANNOUNCEMENT**

It is recommended that this announcement be made prior to every game.

Good (Evening/Afternoon/Morning) (Ladies and Gentlemen/Hockey Fans). Welcome to (Tonights/Todays/This Mornings) game between \_\_\_\_\_ and \_\_\_\_\_.

These are young hockey players who are performing here (Tonight/Today). They are friendly rivals as members of opposing teams. They are not enemies.

The coaches for (Tonights/Todays/This Mornings) game are \_\_\_\_\_ and \_\_\_\_\_. They have accepted the challenge of teaching the skills of this great game.

The officials are \_\_\_\_\_ and \_\_\_\_\_. These individuals have been assigned to administer the rules of the game. Their training, experience and integrity qualify them for their role in this contest.

On behalf of the (Team/Association) \_\_\_\_\_ enjoy our great game of skill.

## HOCKEY CANADA OFFICES

www.hockeycanada.ca

E-mail: info@hockeycanada.ca

### CALGARY OFFICE

2424 University Dr. N.W.  
Calgary, AB T2N 3Y9  
Tel.: (403) 777-3636  
Fax: (403) 777-3635

### OTTAWA OFFICE

801 King Edward Ave, Suite N204  
Ottawa, ON K1N 6N5  
Tel.: (613) 562-5677  
Fax: (613) 562-5676

## BRANCH OFFICES

### BC HOCKEY

6671 Oldfield Rd.  
Saanichton, BC V8M 2A1  
Tel number : (250) 652-2978  
Fax number : (250) 652-4536  
www.bchockey.net

### HOCKEY ALBERTA

#1, 7875-48th Ave.  
Red Deer, AB T4P 2K1  
Tel number : (403) 342-6777  
Fax number : (403) 346-4277  
www.hockeyalberta.ca

### SASKATCHEWAN

#### HOCKEY ASSOCIATION

#2-575 Park Street  
Regina, SK S4N 5B2  
Tel number : (306) 789-5101  
Fax number : (306) 789-6112  
www.sha.sk.ca

### HOCKEY MANITOBA

145 Pacific Ave  
Winnipeg, MB R3B 2Z6  
Tel number : (204) 925-5755  
Fax number : (204) 925-5761  
www.hockeymanitoba.mb.ca

### HOCKEY NORTHWESTERN ONTARIO

216 Red River Road  
Suite 100  
Thunder Bay, ON P7B 1A6  
Tel number : (807) 623-1542  
Fax number : (807) 623-0037  
www.hockeyhno.com

### ONTARIO HOCKEY FEDERATION

3 Concorde Gate Suite 212  
Toronto, ON M3C 3N7  
Tel number: (416) 426-7249  
Fax number: (416) 426-7347  
www.ohf.on.ca

### OTTAWA DISTRICT HOCKEY ASSOCIATION

1247 Kilborn Place  
Suite D-300  
Ottawa, ON K1H 6K9  
Tel number : (613) 224-7686  
Fax number : (613) 224-6079  
www.odha.com

### HOCKEY QUEBEC

7450 boul. Les Galeries d'Anjou  
Bureau 210  
Montreal, QC H1M 3M3  
Tel number : (514) 252-3079  
Fax number : (514) 252-3158  
www.hockey.qc.ca

### HOCKEY NEW BRUNSWICK

861 Woodstock Road  
Fredericton, NB E3B 7R7  
Tel number : (506) 453-0089  
Fax number : (506) 453-0868  
www.hnb.ca

### HOCKEY NOVA SCOTIA

6300 Lady Hammond Rd.,  
Suite 200  
Halifax, NS B3K 2R6  
Tel number : (902) 454-9400  
Fax number : (902) 454-3883  
www.hockeynovascotia.ca

### HOCKEY P.E.I.

P.O. Box 302  
40 Enman Crescent  
Charlottetown, PE C1A 7K7  
Tel number : (902) 368-4334  
Fax number : (902) 368-4337  
www.hockeypei.com

### HOCKEY NEWFOUNDLAND AND LABRADOR

13B High Street  
P.O. Box 176  
Grand Falls Windsor, NL A2A 2J4  
Tel number : (709) 489-5512  
Fax number : (709) 489-2273  
www.hockeynl.ca

### HOCKEY NORTH

3506 McDonald Drive  
Yellowknife, NT X1A 2H1  
Tel number: (867) 920-2729  
Fax number: (867) 920-2739  
www.hockeynorth.ca

## HOCKEY CANADA REGIONAL CENTRES

### ATLANTIC

125 Station  
 Saint John, NB E2L 4X4  
 Tel: (506) 652-2263  
 Fax (506) 652-6641

### QUEBEC

Bell Centre  
 1275 St-Antoine Street W.  
 Montreal, QC H3C 5H8  
 Tel: (514) 925-2240  
 Fax: (514) 925-2243

### WESTERN

Father David Bauer Arena  
 2424 University Dr. NW  
 Calgary, AB T2N 3Y9  
 Tel: (403) 777-3636  
 Fax: (403) 777-3635

### ONTARIO

400 Kipling Avenue  
 Toronto, ON M8V 3L1  
 Tel: (416) 548-9683  
 Fax: (416) 251-5770

## LIFE MEMBERS

Mr. Don Johnson  
 68 Fox Avenue, St. John's, Nfld. A1B 2J2

Mr. Frank McKinnon  
 #13-677 St. Anne Road, Winnipeg, MB R2N 4C4

Mr. Frank Libera  
 4016 McBean, Richmond, Ontario K0A 2Z0

Mr. Gordon Renwick  
 1425 Bishop St. North, Cambridge, Ontario N1R 6S9

Mr. Clair Sudsbury  
 148 Brennan Avenue, Summerside, PE C1N 2K7

### \*\*Deceased Life Members

\*\* Mr. C.C. Robinson

\*\* Mr. Frank Sargent

\*\* Mr. Wm. Northey

\*\* Mr. Jack Devine

\*\* Capt. Jas T. Sutherland

\*\* Mr. The Hon. Justice J.J. Kryczka

\*\* Mr. W.A. Fry

\*\* Mr. Gordon Jukes

\*\* Dr. W.G. Hardy

\*\* Mr. Lionel Fleury

\*\* Mr. Cecil Duncan

\*\* Mr. Art Potter

\*\* Mr. A.W. Pickard

\*\* Mr. Fred Page

\*\* Mr. W.A. Hewitt

\*\* Mr. Robert Lebel

\*\* Mr. J.A. Dunn

\*\* The Hon. Mr. Hanson T. Dowell

\*\* Mr. Earl Dawson

\*\* Mr. Roland Mercier

**MESSAGE FROM THE HOCKEY CANADA BOARD OF DIRECTORS**

The rules which are contained in this book are the only rules which are to be used in the playing of hockey under the jurisdiction of Hockey Canada. Branches or leagues choosing to play outside these rules will be subjected to discipline and will at a minimum, forfeit the right to Hockey Canada's Insurance Program. However, during internal Branch competition, Branches may make variations to Hockey Canada Official Rules, providing these variations are more restrictive than the rules as written.

A game should be refereed strictly in accordance with the rules. In individual cases, Referees may feel that the rules are in some respect not satisfactory. However, it is not up to an individual to decide if a rule should or should not be applied. Rules are approved by Hockey Canada's membership and are to be changed only through the democratic process at given periods of time. Referees are directed to thoroughly apply the rules of the Association and of their Branch.

If a Referee has difficulty in the interpretation of any rule, the Referee should consult with the Branch Referee-in-Chief. If such person cannot give a satisfactory interpretation, Hockey Canada's Referee-in-Chief should be contacted.

It is understandable that in a country of the geographic expanse of Canada, a uniform interpretation of the rules may prove somewhat difficult. That, however, is the goal which is to be aimed at, and if the rules are strictly adhered to in all parts of Canada, it should not be hard to come near achieving that goal.

*These playing rules become effective with the commencement of the 2010-2011 season.*

## TABLE OF CONTENTS

Referee's Signals . . . . .	8
Glossary . . . . .	11
<b>Section One – Playing Area . . . . .</b>	<b>14</b>
<b>Section Two – Teams . . . . .</b>	<b>19</b>
<b>Section Three – Equipment . . . . .</b>	<b>29</b>
<b>Section Four– Penalties . . . . .</b>	<b>46</b>
<b>Section Five – Officials . . . . .</b>	<b>80</b>
<b>Section Six – Physical Fouls . . . . .</b>	<b>88</b>
<b>Section Seven – Restraining Fouls . . . . .</b>	<b>99</b>
<b>Section Eight – Stick Fouls . . . . .</b>	<b>104</b>
<b>Section Nine – Other Fouls . . . . .</b>	<b>108</b>
<b>Section Ten – Game Flow . . . . .</b>	<b>123</b>
Appendixes . . . . .	151
Cross Reference . . . . .	157
Adjustment of Equipment. . . . .	Rule 3.1 . . .29
Aggressor . . . . .	Rule 6.7 . .93
Alternate Goaltender . . . . .	Rule 2.6 . .25
Appointment of Officials. . . . .	Rule 5.1 . .80
Attacking Zone . . . . .	Rule 1.3 . .14
Attempt to Injure . . . . .	Rule 6.1 . .88
Awarded Goals . . . . .	Rule 4.10 . .65
Bench Minor Penalties . . . . .	Rule 4.3 . .52
Biting . . . . .	Rule 6.1 . .88
Boarding . . . . .	Rule 6.2 . .89
Body Checking . . . . .	Rule 6.2 . .89
Broken Sticks . . . . .	Rule 3.2 . .31
Butt-Ending . . . . .	Rule 6.1 . .88
	Rule 8.1 . .104
Calling of Penalties . . . . .	Rule 4.13 . .71
Captain of the Team . . . . .	Rule 2.4 . .20
Centre Ice Spot and Circle . . . . .	Rule 1.6 . .15
Change of Players . . . . .	Rule 2.5 . .22
Charging . . . . .	Rule 6.3 . .90
Checking from Behind . . . . .	Rule 6.4 . .90
Checking to the Head . . . . .	Rule 6.5 . .92
Composition of Team . . . . .	Rule 2.1 . .19
Cross Reference . . . . .	157
Cross-Checking . . . . .	Rule 8.2 . .104
Dangerous Equipment . . . . .	Rule 3.7 . .44
Defending Zone . . . . .	Rule 1.3 . .14
Delay of Game. . . . .	Rule 10.1 .123
Delayed Penalties . . . . .	Rule 4.12 . .70
Deliberate Illegal Substitution . . . . .	Rule 2.5 . .22
Deliberate Injury . . . . .	Rule 6.1 . .88
Diving . . . . .	Rule 9.3 .113
Division of Ice Surface . . . . .	Rule 1.3 . .14
Dressing Rooms . . . . .	Rule 1.13 . .18
Elbowing . . . . .	Rule 6.6 . .93
End Zone Face-off Restraining Lines (Illustration) . . . . .	Appendix G . 157
End Zone Face-off Spots (Illustration)Appendix G .	157
End Zone Face-off Spots and Circles . Rule 1.8 .	.16
Equipment . . . . .	Section 3 . .29
Examples of Minor Penalties . . . . .	.76
Examples of Coincident Major/Match Penalties . .	.77
Face-off Spots in Neutral Zone . . . . .	Rule 1.7 . .15
Face-offs . . . . .	Rule 10.2 .125
Facial Protection . . . . .	Rule 3.6 . .38
Falling on the Puck . . . . .	Rule 10.3 .130
Female Hockey Supplement. . . . .	148
Fighting . . . . .	Rule 6.7 . .93
Game Ejection Penalties . . . . .	Rule 4.6 . .56
Game Misconduct Penalties . . . . .	Rule 4.6 . .56
Game Timekeeper . . . . .	Rule 5.7 . .86
Glossary . . . . .	11
Goal Judges . . . . .	Rule 5.4 . .85
Goal Crease . . . . .	Rule 1.5 . .15
Goal Posts and Nets . . . . .	Rule 1.4 . .14
Goals . . . . .	Rule 10.4 .132
Goaltender Penalties . . . . .	Rule 4.11 . .69
Goaltender's Equipment . . . . .	Rule 3.5 . .35
Goaltender's Stick (Illustration) . . . . .	Appendix A .151
Goaltender's Gloves and Pads (Illustration) . . . . .	Appendix B .152
Grabbing Throat Protector. . . . .	Rule 6.1 . .88
Grabbing Helmet . . . . .	Rule 6.1 . .88
Grabbing Chin Strap . . . . .	Rule 6.1 . .88
Grabbing Facial Protector. . . . .	Rule 6.1 . .88
Gross Misconduct Penalties . . . . .	Rule 4.7 . .57
Handling the Puck . . . . .	Rule 9.1 . .108
Harrassment of Officials. . . . .	Rule 9.2 .110
Head Butting . . . . .	Rule 6.1 . .88
Helmets . . . . .	Rule 3.6 . .38
High Sticks . . . . .	Rule 8.3 .104
Holding . . . . .	Rule 7.1 . .99
Holding the Stick . . . . .	Rule 7.1 . .99
Hooking . . . . .	Rule 7.2 . .99
Icing the Puck . . . . .	Rule 10.5 .134
Illegal Puck . . . . .	Rule 10.12 .142
Illegal Substitution. . . . .	Rule 2.5 . .22
Ineligible Player . . . . .	Rule 9.5 .113
Injured Players. . . . .	Rule 2.6 . .25
Instigator. . . . .	Rule 6.7 . .93
Interference. . . . .	Rule 7.3 . .99
Interference by/with Spectators . . . . .	Rule 10.6 .137
	Rule 6.1 . .88

Junior and Senior Hockey Optional Rules . . . . .	150	Refusing to Start Play. . . . .	Rule 10.14. .144
Kick Shot . . . . .	Rule 9.4. .113	Rink . . . . .	Rule 1.1. .14
Kicking the Puck . . . . .	Rule 10.7. .137	Rink (Illustration). . . . .	Appendix C. .153
Kicking . . . . .	Rule 6.1. .88	Rink Lighting. . . . .	Rule 1.14. .18
Kneeing. . . . .	Rule 6.6. .93	Rink Dimensions . . . . .	Rule 1.2. .14
		Roughing. . . . .	Rule 6.7. .93
Leaving the Players' or Penalty Bench . . . . .	Rule 9.5. .113	Senior Hockey Optional Rules . . . . .	149
Linesmen . . . . .	Rule 5.3. .82	Signal and Timing Devices . . . . .	Rule 1.12. .17
Major Penalties . . . . .	Rule 4.4. .53	Skates . . . . .	Rule 3.4. .35
Match Penalties. . . . .	Rule 4.8. .57	Slashing . . . . .	Rule 8.4. .107
Measurement Guidelines . . . . .	29	Slew Footing . . . . .	Rule 7.4. .102
Minor Hockey Supplement . . . . .	147	Spearing. . . . .	Rule 6.1. .88
Minor Penalties . . . . .	Rule 4.2. .47		Rule 8.5. .107
Misconduct Penalties. . . . .	Rule 4.5. .56	Spitting. . . . .	Rule 9.7. .119
Misconduct . . . . .	Rule 4.5. .56	Start of Game and Periods. . . . .	Rule 10.15. .145
Neutral Zone . . . . .	Rule 1.3. .14	Sticks . . . . .	Rule 3.3. .34
Neutral Zone Face-off Spots (Illustration). . . . .	Appendix G. .157	Substitute (back-up) Goaltender . . . .	Rule 2.2. .19
Off-sides . . . . .	Rule 10.8. .137	Team Colors . . . . .	Rule 2.1. .19
Official Scorer . . . . .	Rule 5.6. .85	Team Roster . . . . .	Rule 2.3. .20
Officials. . . . .	Section 5. .80	Teams . . . . .	Section 2. .19
Overtime . . . . .	Rule 10.16. .146	Third Man Into a Fight . . . . .	Rule 6.7. .93
Passes . . . . .	Rule 10.9. .142	Throat Protection. . . . .	Rule 3.6. .38
Penalties . . . . .	Section 4. .46	Throwing Stick/Object . . . . .	Rule 9.8. .120
Penalties. . . . .	Rule 4.1. .46	Tied Game. . . . .	Rule 10.16. .146
Penalty Timekeeper . . . . .	Rule 5.5. .85	Time of Game . . . . .	Rule 10.17. .146
Penalty Bench . . . . .	Rule 1.10. .17	Time Out. . . . .	Rule 10.17. .146
Penalty Options Chart . . . . .	Appendix D. .154	Too Many Men on the Ice. . . . .	Rule 2.5. .22
Penalty Shot . . . . .	Rule 4.9. .58	Tripping. . . . .	Rule 7.4. .102
Physical Abuse of Officials . . . . .	Rule 9.6. .119	Amateur hockey in Canada is played by men, women, boys and girls from coast to coast. Within this publication the alternating of gender in both photographs and grammar is utilized. Any masculine reference shall also apply to female hockey and any feminine reference shall apply to male hockey. This is to encourage the widest possible involvement in our great game!	
Players in Uniform . . . . .	Rule 2.2. .19		
Players' Bench . . . . .	Rule 1.9. .16		
Player's Stick (Illustration) . . . . .	Appendix A. .151		
Playing Area. . . . .	Section 1. .14		
Premature Substitution . . . . .	Rule 2.5. .22		
Protection of the Goaltender . . . . .	Rule 7.3. .99		
Protective Equipment. . . . .	Rule 3.6. .38		
Puck . . . . .	Rule 3.8. .45		
Puck (Illustration) . . . . .	Appendix A. .151		
Puck Must be Kept in Motion . . . . .	Rule 10.10. .142		
Puck Out of Bounds or Unplayable . . . . .	Rule 10.11. .142		
Puck Out of Sight. . . . .	Rule 10.12. .144		
Puck Striking Official . . . . .	Rule 10.13. .144		
Pulling Hair . . . . .	Rule 6.1. .42		
Referee and Linesmen . . . . .	Rule 5.2. .80		
Referee's Crease . . . . .	Rule 1.11. .17		
Referee's Signals. . . . .	8		



## REFEREE'S SIGNALS

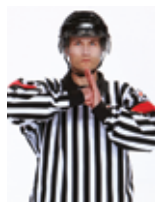

### BOARDING

Striking the clenched fist of one hand into the open palm of the opposite hand in front of the chest.

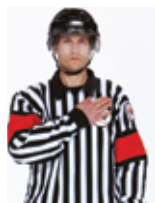

### BODYCHECKING

Open palm of the non-whistle hand, with fingers together, comes across body on to the opposite shoulder.

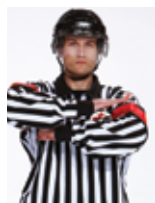

### BUTT-ENDING

A cross motion of the fore-arms, one moving under the other arm.



### CHARGING

Rotating clenched fists around one another in front of the chest.

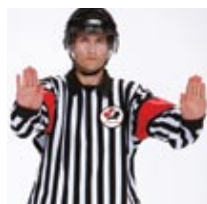

### CHECKING FROM BEHIND

A forward motion of both arms, with the palms of the hands open and facing away from the body, fully extended from the chest at shoulder level.

extended from the chest at shoulder level.

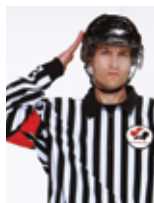

### CHECKING TO THE HEAD

Patting flat (open palm) of the non-whistle hand on this side of the head.

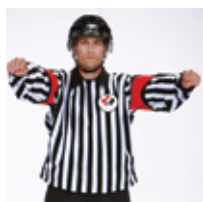

### CROSS-CHECKING

A forward and backward motion of the arms with both fists clenched, extending from the chest for a distance of about one foot.



### DELAYED OFF-SIDE

Non-whistle arm fully extended above the head. To nullify a delayed off-side the Linesman shall drop the arm to the side.



### DELAYED CALLING PENALTY

Extending the non-whistle arm fully above the head.



### ELBOWING

Tapping either elbow with the opposite hand.



### GOAL SCORED

A single point directed at the goal in which the puck legally entered.

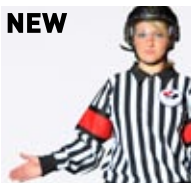
**NEW****HAND PASS**

Pushing motion with the open palm.

**HIGH STICKING**

Holding both fists clenched, one immediately above the other at the height of the forehead.

**HOLDING**

Clasping either wrist with the other hand in front of the chest.

**HOLDING THE STICK**

Two stage signal involving the holding signal (shown above) followed by a signal indicating you are holding onto a stick with two hands in a normal manner.

**HOOKING**

A tugging motion with both arms as if pulling something from in front toward the stomach.

**ICING THE PUCK**

The back Referee or Linesman signals a possible icing by fully extending either arm over her head. The arm should remain raised until the front Referee or Linesman, either blows the whistle to indicate an icing or until the icing is washed out. Once the icing has been completed, the back Referee or Linesman will then point to the appropriate face-off spot and skate to it.

**INTERFERENCE**

Crossing arms stationary in front of the chest.

**KNEEING**

Slapping either knee with the palm of the hand, while keeping both skates on the ice.

**MATCH PENALTY**

Patting flat of the hand on the top of the head.

**MISCONDUCT**

Both hands on hips.

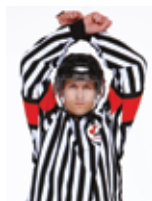

### **PENALTY SHOT**

Arms crossed above the head. Give the signal upon stoppage of play.



### **WASH OUT**

A sweeping sideways motion of both arms across the front of the

body at shoulder level with palms down. This signal is used: (a) by the Referee to signal “no goal”; (b) by the Linesman to signal “no icing” and in certain situations “no off-side”.



### **ROUGHING**

Fist clenched and arm extended out to the front or side of the body.



### **SLASHING**

A chopping motion with the edge of one hand across the opposite forearm.

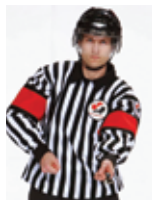

### **SPEARING**

Jabbing motion with both hands thrust out immediately in front of the body and then hands dropped to the side of the body.



### **TRIPPING**

Striking leg with either hand below the knee, keeping both skates on the ice.



### **UNSPORTSMANLIKE CONDUCT/DIVING**

Using both hands to form a “T” in front of the chest.

## GLOSSARY

**AGGRESSOR:** Player attempting to continue a fight by throwing or attempting to throw punches or again by continuing the grappling action with his opponent with the intent of intimidation or punishment of that opponent. The aggressor may or may not be the instigator of the fight.

**ALTERCATION:** Altercation is defined as any incident involving players leading to a penalty or penalties.

**ATTEMPT TO OR DELIBERATE INJURY:** An action by a player or team official who by the use of a stick, skate or other object, or by using her body, hits or attempts to hit an opposing player or team official, or game official with the intention of causing injury.

**BREAKAWAY:** A player in full control of the puck in the neutral or attacking zone, and having no opposing player between himself and the opposing goaltender (or goal, if the goaltender has been removed).

**BROKEN STICK:** A stick that in the opinion of the Referee is unfit for normal play.

**BUTT-ENDING:** The action whereby a player uses the shaft of the stick, above the upper hand, to check an opposing player in any manner or jabs or attempts to jab an opposing player with this part of his stick.

**BUTT-END HOOKING:** The action whereby a player uses the shaft of the stick above the upper hand to hold or hook an opponent.

**CAPTAIN:** A player, other than a goaltender, who is selected or named by the team, to represent the team with the officials. Wherever the word "Captain" appears in the Rule Book, it defines those players who have been designated as Captain or Alternate Captain on the Official Game Report.

**CHARGING:** The act of taking more than two steps or strides to contact an opposing player.

**CHECKING FROM BEHIND:** Any action where a player is intentionally pushed, body-checked, high sticked, cross-checked or hit in any manner from behind.

**COACH:** A person primarily responsible for directing and guiding the actions and efforts of his team. Along with the Manager, he is responsible for the conduct of the players before, during and after the game in the arena.

**CONTROL:** A player actually propelling the puck with her stick, skate(s) or glove(s).

**CREASES:** Identifies enclosed space designated for the protection of the goaltender and the use of the Referee in the discharge of their respective duties. The lines which designate this space are to be considered part of the crease.

**CROSS-CHECKING:** The action of using the shaft of the stick between the two hands to check an opponent at any height.

**DELAYED OFF-SIDE:** A situation where an attacking player (players) has (have) preceded the puck across the attacking blue line, but the defending team is in a position to bring the puck back out of its defending zone without any delay or contact with an attacking player.

**ENCROACHMENT:** This occurs when a player other than the centre stands with a skate either inside the face-off circle, on the face-off circle or in the area between the hash marks prior to the dropping of the puck. It is acceptable for the player's stick to be inside the face-off circle but not in the area between the hash marks.

**FACE-OFF:** The action of the Referee or Linesman in dropping the puck between the sticks of two opposing players to start or resume play. A face-off begins when the Referee indicates the location of the face-off and the officials and players take their appropriate positions. It ends when the puck has been legally dropped.

**GAME:** A meeting of two teams playing for a specific length of time, for the purpose of declaring a winner through the scoring of goals. The game consists of regular playing time and overtime, if such is required.

**GAME EJECTION:** When a player has been removed from the game for three or more stick infraction penalties, this player must leave the area of the players' bench and must in no way direct, coach or assist the team in any manner for the remainder of the game.

**GATHERING:** When one or more players of one team come in close contact with one or more opposing players in such a manner as to create the possibility of a penalty or penalties against one or more of the players.

**GOALTENDER:** A person designated as such on the Official Game Report, who is identified by the use of special and legal equipment and privileges to prevent the puck from entering the net.

**GOALTENDERS' SKATES:** Skates specifically designated for use by goaltenders. The blade of the skate is closed at both ends and is specially constructed so as to prevent the puck from passing through the blade.

**HEEL OF THE STICK:** The point where the shaft of the stick and the bottom of the blade meet.

**HIGH STICKING:** The action of the player carrying the stick or any part of the stick above the normal height of the shoulder.

**HOLDING:** Any action by a player that retards the progress of an opposing player whether or not she is in possession of the puck.

**HOOKING:** The action of using the blade of the stick in a "pulling or tugging" motion to impede the progress of an opponent. The hooking action may apply to any part of an opponent's body or stick.

**INSTIGATOR:** The player responsible for starting a fight by throwing or attempting to throw the first punch(es).

**KICKING:** The action of a player deliberately using his skate(s) with a kicking motion to contact an opponent, with no intent to play the puck.

**KICK SHOT:** The action of placing the blade of the stick behind the puck and then propelling the puck by kicking the stick.

**OFF-ICE OFFICIALS:** Officials appointed to assist the On-Ice Officials in the conduct of the game. They are under the control of the Referee during the game, and include: Official Scorer, Game Timekeeper, Penalty Timekeeper, and two Goal Judges.

**ON-ICE OFFICIALS:** The On-Ice Officials are the Referee and Linesmen.

**PENALTY:** The result of an infraction to the rules.

**PLAYERS:** The members of the team physically participating in a game. Except where special rules apply to him, the goaltender is to be considered a player.

**PLAYERS IN UNIFORM:** Players duly registered on the Official Game Report and attired in the appropriate protective equipment in order to participate in the game.

**POSSESSION:** The state of a player other than a goaltender who is the last one to have come in contact with the puck. **The goaltender must have had control of the puck before he is deemed to be in possession.**

**PRESIDENT:** Where the word "President" is used in the Rule Book, it shall refer to the President of Hockey Canada Branch or his duly appointed representative for games under the jurisdiction of the branch; otherwise it shall refer to the President of Hockey Canada.

**PROTECTIVE EQUIPMENT:** The equipment worn by a player for the sole purpose of protecting against injury.

**SHORTHANDED:** Shorthanded means that a team is below the numerical strength of its opponent on the ice.

**SLASHING:** The action of hitting an opponent with a stick while holding the stick with one or both hands. Tapping the stick of the puck carrier is not considered slashing if it is for the sole purpose of taking the puck. A player who swings his stick at an opponent and makes no contact shall still be guilty of slashing.

**SLEW FOOTING:** The action of tripping a player by knocking a player's skates out from behind with a kicking or leg dragging motion.

**SPEARING:** The action of poking or attempting to poke an opponent with the toe of the blade of the stick while holding the stick with one or both hands.

**TEAM OFFICIAL:** The five people clearly identified on the Official Game Report which may include the Coach, Manager, Trainer, Stick Boy, Team Doctor, President and other members of the executive of the team.

**TIME PENALTY:** A penalty which at any time results in a team playing with less than six players on the ice. i.e., Minor, Bench Minor, Major or Match penalty.

## **NEW SUPPLEMENTARY DISCIPLINE**

**In addition to the penalties contained in this Rulebook, supplementary discipline will be assessed to Players, Teams and/or Team Officials for enumerated penalties set out in the appropriate Minimum Suspension Chart contained in the Hockey Canada Articles, By-Laws, Regulations and History publication.**

**For greater certainty, the Minimum Suspension Charts are in no way intended to preclude any Branch, Association, or League from expanding the categories of penalties for which supplementary discipline may be assessed or from assessing supplementary discipline that exceeds the minimums set out in the appropriate Minimum Suspension Chart.**

## SECTION 1 PLAYING AREA

### Rule 1.1 Rink

Ice Hockey shall be played on an area of ice called a “Rink”.

### Rule 1.2 Rink Dimensions

**NEW (a) As nearly as possible, the dimensions of a new rink are recommended to be a maximum of 60.96m (200 ft.) long and 30.48m(100 ft.) wide or a minimum of 60.96m (200 ft) long and 25.91m (85 ft) wide. The corners shall be rounded in the arc of a circle with a radius of 8.53 m (28 ft). This shall apply to new rinks only.**

- (b) The rink shall be enclosed by the boards, which may be constructed of wood, plastic or fibreglass. Measured from the surface of the ice, the boards shall be no more than 1.22 m (4 ft. ) and no less than 1.02 m (3 ft. 4 in.) in height. The surface of the boards facing the ice shall be white and free from any obstruction or object that may cause injury to players. The base plate, of a maximum height of 30.48 cm (12 in.), shall be light (recommend yellow) in colour.
- (c) It is recommended that glass, plexi-glass or other similar material be mounted to the boards, flush to the playing surface, to assist in the prevention of pucks going into the spectator areas. Protection is also recommended in front of the off-ice officials area. All equipment used to hold the glass or similar material in position, shall be mounted on the boards on the side away from the playing surface.
- (d) It is recommended that no logos or advertising be allowed on the ice in the end zones. Logos must not disrupt or alter any official ice markings as described in this Section One.

### Rule 1.3 Division of Ice Surface

- (a) 3.35 m (11ft.) from each end of the rink, a red line, 5.08 cm (2 in.) wide, shall be marked on the ice parallel to the end boards. This line shall extend across the rink and be known as the “Goal Line”
- (b) On rinks 56.39 m (185 ft.) or more in length, blue lines, 30.48 cm (12 in.) wide, shall be marked on the ice parallel to the goal lines at a point 19.5 m (64 ft.) from each goal line, while the neutral zone shall take up the remaining space in the centre ice area. These lines shall extend across the ice surface and vertically on each side board and shall be known as the “Blue Lines”.  
  
On rinks less than 56.39 m (185 ft.) in length, the blue lines shall be positioned so they divide the distance between the goal lines into three equal areas.
- (c) Midway between the goal lines, a red line, 30.48 cm (12 in.) wide, shall be marked on the ice and extend vertically up the side boards, parallel to the goal lines. This line shall be known as the “Centre Red Line”.
- (d) That portion of the ice surface in which the goal is situated shall be called the “DEFENDING ZONE” of the team defending that goal; the central portion shall be known as the “NEUTRAL ZONE”, and that portion furthest from the defended goal as the “ATTACKING ZONE”.

**Rule 1.4 Goal Posts and Nets**

- (a) In the centre of the goal lines between the side boards, regulation goal posts and nets of approved design and materials, shall be placed in such a manner as to remain stationary during the game. It is recommended that nets be restrained by magnetic, breakaway or similar types of fastening devices in Hockey Canada games.
- (b) The goal posts shall be set 1.83 m (6 ft.) apart, measured from the inside of the posts. They shall extend 1.22 m (4 ft.) vertically from the ice surface and a cross bar of the same material as the goal posts shall be extended horizontally from the top of the other posts. The cross bar should be securely fastened to both goal posts. The outside measurement of both the goal posts and the cross bar shall be 5.08 cm (2 in.) in diameter. The area enclosed by the goal posts and the cross bar shall be known as “the goal”.
- (c) A net of approved design and material shall be attached to the back of each goal.
- (d) The goal posts, cross bar and the exterior surface of other supporting framework for the goal shall be painted red. The surface of the base plate inside the goal and supports other than the goal post shall be painted in a light colour.

**Rule 1.5 Goal Crease**

- (a) In front of each goal, a “Goal Crease” area shall be marked by a red line 5.08 cm (2 in.) wide.
- (b) The goal crease shall be laid out as follows: a semi-circle 1.82 m (6 ft.) in radius and 5.08cm (2 in.) in width shall be drawn using the centre of the goal line as the centre point. In addition, an “L” shaped marking of 12.7cm (5 in.) in length (both lines) at each front corner will be painted on the ice. The location of the “L” shaped marking is measured by drawing an imaginary 1.22 m (4 ft.) line from the goal line to the edge of the semi-circle. At that point, the “L” may be drawn. The interior colouring of the crease shall be light blue, light yellow or off-white.
- (c) The goal crease area shall include the space outlined by the crease lines and shall extend vertically to the level of the top of the goal frame.

**Rule 1.6 Centre Ice Spot and Circle**

A circular blue spot, 30.48 cm (12 in.) in diameter, shall be marked on the ice exactly in the centre of the rink. Using this spot as a centre, a circular blue line, 5.08cm (2 in.) wide, with a radius of 4.57m (15 ft.), will then be marked on the ice.

**Rule 1.7 Face-off Spots in Neutral Zone**

Two red spots 60.96 cm (2 ft.) in diameter, shall be marked on the ice in the Neutral Zone, 1.52 m (5 ft.) from each blue line, and the same distance from the boards as the end zone face-off spots. Within each face-off spot draw two parallel lines 7.62 cm (3 in.) from the top and bottom of the spot. The area within the two lines shall be painted red, the remainder shall be painted white.



**Rule 1.8 End Zone Face-off Spots and Circles**

- (a) In both end zones and on both sides of each goal, red face-off spots and circles shall be marked on the ice. The face-off spots shall be 60.96cm (2 ft.) in diameter and the circles shall have a radius of 4.57 m (15 ft.) from the centre of the face-off spots. The lines of the circle shall be 5.08 m (2 in.) wide. 5.64 m (18 1/2ft.) and 6.55 m (21 1/2ft.) from the goal line and parallel to it, two red lines 60.96 cm (2 ft.) in length and 5.08cm (2 in.) wide shall be marked on the ice extending from the outer edge of both sides of each face-off circle. The face-off spots shall be 60.96 cm (2 ft.) in diameter. Within each face-off spot draw two parallel lines 7.62 cm (3 in.) from the top and bottom of the spot. The area within the two lines shall be painted red, the remainder shall be painted white. 30.48 cm (1 ft.) away from the edge of the face-off spot, two lines shall be drawn parallel with the sideboards that shall be 1.22 m (4 ft.) in length and 45.72 cm (18 in.) apart. Parallel to the end boards, commencing at the end of the line nearest to the face-off spot, a line shall extend 86.36 cm ( 2 ft. 10 in.) in length. All lines shall be 5.08 cm (2 in.) in width.
- (b) The location of the face-off spot shall be fixed in the following manner: Along a line 6.09 m (20 ft.) from each goal line and parallel to it, mark two points 6.71 m (22 ft.) on both sides of the straight line joining the centres of the two goals. Each such point shall be the centre of the face-off spot and circle.
- (c) For rinks under 22.90 m (75 ft.) in width, the face-off circles shall be reduced in circumference so that they do not overlap. A minimum area of 60.96 cm (2 ft.) from the adjacent side boards is to be maintained.

**Rule 1.9 Players' Bench**

- (a) Each rink shall have seats or a bench for the use of each team, to be known as the "Players' Bench". Each players' bench shall accommodate at least fourteen players and shall be placed directly alongside the ice in the neutral zone, as near as possible to the centre of the rink and convenient to the dressing rooms. Whenever possible, a walking space of 91.44 cm (3 ft.) should be left open behind the players' bench (new rinks).
- (b) The gates to the players' bench should be constructed to open away from the ice surface.
- (c) Only players in uniform and a maximum of five team officials shall be permitted to occupy the players' bench. These individuals shall be registered and entered on the Official Game Report. A maximum of five team officials may be recorded on the Official Game Report.
- (d) During a game, Coaches, Managers, Trainers and Stick Boys or other authorized team officials shall be restricted to the use of the area the length of their players' bench, including their team's gate. The penalty for a violation of this rule is a Bench Minor penalty.
- (e) The Home Team shall have the choice of ends to start the game and must take the players' bench that corresponds to their choice of ends. Teams shall alternate ends of the ice to start each period but neither team is permitted to change their players' bench

**SITUATION 1 Rule 1.9 (e)**

*In cases where benches are on opposite sides of the rink, this rule is not applicable and the Home Team may choose either bench.*

**SITUATION 2 Rule 1.9 (e)**

*The Home Team must make their choice of ends prior to the warm-up. The team must then warm-up in the end chosen.*

**Rule 1.10 Penalty Bench**

- (a) Each rink shall have seats or a bench to accommodate eight persons to be known as the "Penalty Bench". It is to be used for the seating of penalized players, the Penalty Timekeeper, the Game Timekeeper and the Official Scorer. The penalty bench should be located a substantial distance from the players' bench.

*Note: The penalty box shall be located on the opposite side of the rink from the players' bench, or if this is not possible, at least 6.09 m (20 ft.) from either bench.*

- (b) The gates of the penalty box should be constructed to open away from the ice surface, and outside the area known as the Referee's crease. In each rink in which inter-branch play-offs are to be played, there shall be two separate penalty boxes, each having its own gate and designated respectively as "Home" and "Visitor". Adequate arrangements shall be made to physically separate members of the opposing teams. Where the penalty gates are located at unequal distances from centre ice, the gate closest to the centre ice shall be designated for the Visiting Team.

**Rule 1.11 Referee's Crease**

A red line, 5.08 cm (2 in.) wide, in the shape of a semi-circle and with a 3.05 m (10 ft.) radius shall be marked on the ice immediately in front of the Penalty Timekeeper's seat. The area enclosed by this line shall be known as the Referee's crease.

**Rule 1.12 Signal and Timing Devices**

- (a) Each rink must have a suitable sound device to be used by the Game Timekeeper.
- (b) Each rink must have a clock in order that spectators, players and game officials may be accurately informed as to the time remaining in the game.

*Note: Where clocks with four faces are in use, the face directly in front of the Game Timekeeper shall govern the time.*

- (c) In a suitable location behind each goal, a red light shall be provided for the use of each Goal Judge in signalling the scoring of a goal. Wherever possible, Hockey Canada recommends that an electric buzzer or bell and a green light be installed in the same location as the red light and that this buzzer or bell and green light be synchronized with the time clock, to provide the Referee with an audible and visual signal for the end of a playing period or game.

*Note: A goal cannot be scored when the green light is showing.*

**Rule 1.13 Dressing Rooms**

- (a) Each rink shall provide a suitable dressing room equipped with a sanitary toilet and shower for the use of the Visiting Team.
- (b) A separate dressing room shall be provided for the use of Referees and Linesmen. It shall be equipped with a sanitary toilet and shower.
- (c) No team official, player or employee of any club may enter into any inappropriate discussion with any Referee during or after a game. No person, except the President of the branch or league or their representative, shall be allowed to enter the Official's dressing room. For any infraction of this rule, the matter shall be reported by the Referee to the President of the branch for further action.

**Rule 1.14 Rink Lighting**

All rinks shall be lighted so that the players and spectators may clearly follow play.

## SECTION 2 TEAMS

### **Rule 2.1 Composition of Team**

- (a) A team shall have no more than six players on the ice at any one time while play is in progress. These six players shall be designated as follows: Goaltender, Right Defence, Left Defence, Centre, Right Wing and Left Wing.
- (b) Each player shall wear an individual number of at least 25.40cm (10 in.) in height on the back of her sweater.

*Note - Team Colours*

*Each team shall declare its colours to the President or Governor of its league at the beginning of each season. If these colours are accepted, they may not be changed during the season without the approval of the League President or Group Governor.*

*In inter-branch competition, it will be the responsibility of the Home Team to change its sweater and socks if the colours of the competing teams conflict. The decision in this matter shall be left to the Referee in charge of the game.*

### **Rule 2.2 Players in Uniform**

- (a) Each team shall be entitled to a maximum of 19 (Jr A, B, Senior (male and female) and AAA Midget -20) players in uniform, (which includes two goaltenders), for any game or pre-game warm-up, all of whom shall be duly registered in accordance with Hockey Canada Regulations. The players duly registered as goaltenders shall be eligible to play as goaltenders only. Teams in inter-branch competition must have both goaltenders in uniform and ready to play. A minimum of six eligible players in uniform (not necessarily a goaltender) on each team shall be necessary to start the game.
- (b) Before the start of the game, the Official in charge of each team shall give the Referee or Official Scorer a list of names and numbers of the players and goaltenders (to the maximum of 19 (Jr A, B, Senior (male and female) and AAA Midget -20) who shall be eligible to play in that game. No change in the list or addition to the list shall be permitted after the commencement of the game except:
  - (1) Where a player is late and his name has been included on the Official Game Report prior to the game, he will be permitted to participate;
  - (2) When a player has been inadvertently omitted from the Official Game Report, the Referee shall permit the name to be added to the Game Report before the game has ended; providing such player was in uniform and on the ice or on his players' bench at the start of the game.
- (c) Any team official who gives a false statement on the Official Game Report with regard to eligible players, shall be dealt with by the President.
- (d) Each team shall be allowed one goaltender on the ice at one time. The goaltender may be removed and another "Player" substituted. Such player shall not be permitted the privileges of a goaltender.
- (e) No player, other than a goaltender or his replacement shall be permitted to wear the equipment of a goaltender. Note: Teams are allowed to dress two goaltenders, either of whom may be used at the team's discretion.

- (f) When the substitute goaltender enters the game, he shall take his position without delay and no warm-up shall be permitted.
- (g) If both teams are on the ice during the pre-game warm-up, players shall be restricted to their own half of the ice. Where a team violates this rule, the Referee shall report the violation to the President who may take appropriate action.
- (h) No player under suspension may participate in the pre-game warm-up or occupy the players' bench.

**SITUATION 1 Rule 2.2 (b)**

*The addition or deletion of players' names to the playing line-up listed on the Official Game Report may be made up to the commencement of the game.*

**SITUATION 2 Rule 2.2 (b)**

*During the pre-game warm-up, a total of 19 players (20 for Junior A, B, Senior (male and female) and Midget AAA) can be dressed and participate in the warm-up. These 19 players (20 for Junior A, B, Senior (male and female) and Midget AAA) do not have to be included on the Official Game Report for the game. If a player is assessed a penalty during the pre-game warm-up, then this player has to be included on the Official Game Report, as per Rule 4.1 (b). A player does not have to participate in the pre-game warm-up in order to be included on the Official Game Report. If a team has more than the 19 players (20 for Junior A, B, Senior (male and female) and Midget AAA) in their pre-game warm-up, the incident must be reported to the League President, but no penalty is assessed. Players may be substituted during the pre-game warm-up, as long as the maximum of 19 players (20 for Junior A, B, Senior (male and female) and Midget AAA) is not exceeded.*

**SITUATION 3****QUESTION:**

*Is it possible to start the game with six players, but without a registered goaltender?*

**ANSWER:**

*Yes. The six players should be listed as players and the goaltender's space should be left blank.*

**SITUATION 4 Rule 2.2 (b)**

*Where a players' number has been recorded incorrectly on the Official Game Report, the Referee shall permit a correction to be made before the game has ended, providing such player was in uniform and on the ice or on his players' bench at the start of the game.*

**Rule 2.3 Team Roster**

Before the start of the game the Official in charge of the Visiting Team must be the first to list her line-ups on the Official Game Report.

**Rule 2.4 Captain of the Team**

- (a) Each team may appoint a Captain and not more than three Alternate Captains. One of these should be on the ice at all times and only a Captain or Alternate Captain who is on the ice shall have the privilege of asking the Referee for his interpretation of any rule during the progress of the game.

Prior to the start of the game, the Manager or Coach of each team shall note on the Official Game Report and advise the Referee or Official Scorer of the names and numbers of the Captain and Alternate Captain(s).

- (b) The Captain shall wear the letter "C" and the Alternate Captain(s) the letter "A" in a conspicuous position on the front of their sweaters. The letters should be in a contrasting colour and be approximately 7.62cm (3 in.) in height. If the letters are not worn, Captain's and Alternate Captain's privileges will not be permitted.
- (c) When the Captain or Alternate Captain receives a penalty, he shall lose all his privileges for the duration of the penalty and must proceed directly to the penalty box. Such players failing to do so will be assessed a Misconduct penalty.
- (d) Goaltenders or a replacement for a goaltender, cannot be selected or named Captain or Alternate Captain.
- (e) A playing Coach or Manager shall not be entitled to the privileges of a Captain or Alternate Captain.
- (f) A Minor penalty for delay of game shall be assessed any Captain, Alternate Captain or other player who leaves his players' bench to discuss any interpretation of the rules with the Referee.

**SITUATION 1 Rule 2.4 (a)**

**QUESTION:**

*A Coach indicates that he does not want to indicate a Captain. Is it acceptable for him to list four Alternate Captains?*

**ANSWER:**

*No, this is not acceptable. A team may not appoint more than three Alternate Captains.*

**SITUATION 2**

**QUESTION:**

*The Team Captain and Alternate(s) are incapacitated by reason of injuries or penalties and the Referee deems it necessary to convey a message to the bench. How does he proceed?*

**ANSWER:**

*The Referee has the authority to select a player on the ice to convey the message to the bench.*

**SITUATION 3 Rule 2.4 (f)**

**QUESTION:**

*A Captain comes off the players' bench to question the Referee, but stays on the ice to take part in the play. Does the Referee assess the Minor penalty immediately?*

**ANSWER:**

*Not immediately.*

*Note: The Referee is not permitted to discuss any interpretation of the rules with the Captain in this situation. The Captain however, must remain on the ice since the line change has been completed. The Referee should use good judgment, and warn the player appropriately that a conversation or discussion is not allowed at this particular time, and that they must now remain on the ice. If the Captain persists in his questioning, or if he returns to the players' bench and leaves the ice, a Minor penalty for Delay of Game should be assessed under Rule 2.4 (f).*

**SITUATION 4 Rule 2.4 (b)**

*In order to exercise the privileges of a Captain or Alternate Captain, the player must be wearing the "C" or "A" on his sweater, regardless of what is on the Official Game Report. If a player is wearing a "C" or an "A" on his sweater and this is not designated on the Official Game Report, then it must be added to the Official Game Report or removed from his sweater.*

**SITUATION 5 Rule 2.4 (a)**

*During a game, the Referee becomes aware that a team has more than the appropriate number of players wearing "C"s or "A"s.*

**RULING:**

*Assess the team a Bench Minor penalty.*

**SITUATION 6 Rule 2.4 (b)**

**QUESTION:**

*Can a player not wearing a "C" or "A" request a measurement of any kind?*

**ANSWER:**

*No.*

**SITUATION 7 Rule 2.4 (a)**

**QUESTION:**

*A Coach indicates that he does not want to indicate a Captain or Alternate Captains. What, if anything, should the Referee do?*

**ANSWER:**

*Nothing. The team simply loses the Captain or Alternate Captain privileges such as the opportunity to request an equipment measurement or a rule interpretation.*

**Rule 2.5 Change of Players**

- (a) When play is in progress, not more than six players (including a goaltender) are permitted on the ice at any one time.
- (b) Players may be changed at any time from the players' bench, provided that the player or players leaving the ice shall be at the players' bench [within 3.05m (10 ft.)] and out of play before any change is made.
- (c) A player on the penalty bench who is to be changed after her penalty has been served must proceed by way of the ice and be at the players' bench before any change can be made.
- (d) A team shall be required to place the correct number of players on the ice when requested by the Referee. The Visiting Team must be the first to place any playing line-up on the ice to commence play at all times. Each team is allowed only one change of player(s) during a stoppage of play.
- (e) A Bench Minor penalty shall be assessed for a violation of any section of this rule. The penalty shall be served by a player committing the infraction, as covered under Rule 4.3 - Bench Minor penalties.
- (f) If, in the last two minutes of regular playing time, or any time in overtime, a Bench Minor penalty is imposed for DELIBERATE illegal substitution, a Penalty Shot shall be awarded against the offending team. The Bench Minor shall not be served. See Rule 10.1 (e) Note - Delay of Game.

*Note 1: If in the course of making a substitution, either the player entering the game or the player leaving the game intentionally plays the puck with her stick, skates or hands or intentionally checks or makes any physical contact with an opposing player while the player respectively leaving or entering the game is actually on the ice, then the infraction of "too many players on the ice" shall be called.*

*Note 2: If in the course of substituting, either the player entering the play or the player retiring is struck by the puck accidentally, the play should not be stopped and no penalty shall be called.*

*Note 3: When a goaltender leaves her goal area, and proceeds to the player's bench for the purpose of substituting another player, she must be within 3.05m (10 ft.) of the bench before the substitute may enter the game. If the substitute is made prematurely, the official shall stop the play when the offending team gains possession and control of the puck.*

*The resulting face-off shall take place at the centre face-off spot, except in cases where the offending team would gain a territorial advantage, in which cases the face-off shall be where the stoppage of play occurred as per Rule 10.2 (g).*

- (g) For player changes during stoppages in play, the Referee shall begin the line change procedure as soon as it is safe to do so for the ensuing face-off and then allow a five-second period during which the Visiting Team may make a player change. After this five-second period has elapsed, the Referee will raise an arm to indicate that the Visiting Team may no longer change any player(s). With the arm still up, the Referee will allow a five-second period during which the Home Team may make a player change. After this five-second period has elapsed, the Referee will drop the arm to indicate that the Home Team may no longer change any player(s).

Where a team attempts to make a player change after their allotted period of time, the Referee shall send the player(s) back to their bench. Any subsequent infraction to this procedure at any time during the course of the game shall incur a Bench Minor penalty under Rule 2.5 (e).

- (h) During a line change in a stoppage of play, if there is a scrum or gathering, the players coming on the ice must remain at their respective benches until the gathering is dispersed and the referee has indicated for the line change to take place. Failure to remain at the team bench may result in a Bench Minor penalty being assessed.

#### SITUATION 1 Rule 2.5 (d)

##### QUESTION:

*During a stoppage of play, teams are changing players. One of the officials drops the puck to start play. Immediately after the play starts, the Referee notices that one of the teams has too many players on the ice. Must the Referee assess a Minor penalty?*

##### ANSWER:

*No. If the Referee notices too many players immediately, she must stop play and correct the situation without assessing a penalty. If the Referee does not notice immediately and play continues with too many players on the ice, a Minor penalty would be assessed.*

#### SITUATION 2 Rule 2.5 (f)

*A player who is about to come on the ice plays the puck with her stick. This player has either one or both skates still on the bench.*

##### RULING:

*Assess a Bench Minor penalty. A player must have both skates on the ice in order to participate in the play. This ruling would apply whether or not the team has the correct number of players on the ice. In the case of the player leaving the ice who plays the puck on the ice with one or both skates on the bench, the same ruling would apply.*



**SITUATION 3 Rule 2.5 (f)**

*Note 3: If either the goaltender coming off, or the player coming on the ice plays the puck while the other one is still on the ice, a penalty for "too many players on the ice" shall be assessed, regardless of whether or not the goaltender is within the 3m (10 ft) area. Before either player can play the puck, the other player must be on the bench. This situation supercedes Note 3.*

**SITUATION 4 Rule 2.5 (b)****QUESTION:**

*Can the goaltenders be changed while play is in progress?*

**ANSWER:**

*Yes. Changing goaltenders "on the fly" is governed by the same rules that apply to the changing of players.*

**SITUATION 5 (a), (b), (c) below**

*Please refer to both Rule 2.5 - Change of Players and Rule 4.10 - Awarded Goals*

**SITUATION 5 (a)**

*A goaltender has been removed for an extra attacker. The opposing team gets a breakaway. The goaltender comes back on the ice and throws her stick at the puck or puck carrier in the neutral or attacking zone.*

**RULING:**

*Award a Goal. The goaltender is classified as being off the ice while the team has an extra player on the ice.*

**SITUATION 5 (b)**

*A goaltender is on her way to the bench to be replaced by an extra attacker. As soon as the goaltender is close enough to the bench, a substitute goes on the ice. The opposing team gains possession and control of the puck and gets a breakaway. A player or the goaltender (on her way to the bench) throws her stick at the puck or puck carrier in the neutral or attacking zone.*

**RULING:**

*Award a Goal. The goaltender is classified as being off the ice once the extra player is on the ice, even though the goaltender may not have actually left the ice at this point.*

**SITUATION 5 (c)**

*A goaltender is just out of her goal crease and on her way to the bench (but the substitute is not yet actually on the ice) and a stick is thrown at a player on a breakaway in the neutral or attacking zone and no goal is scored.*

**RULING:**

*Award a Penalty Shot. The goaltender is classified as still being on the ice. Therefore, only the Penalty Shot is awarded.*

**SITUATION 6 Rule 2.5 (f)**

*During a delayed penalty situation against Team "B", Team "A" is in possession of the puck in their defending zone. There is a stoppage of play for premature substitution of Team "A" goaltender.*

**RULING:**

*The face-off shall take place at the nearest neutral zone face off outside Team "A" defending zone.*

**SITUATION 7 Rule 2.5 (d) and Rule 2.5 (e)**

*Note 1: At times there have been problems resulting from the situation where upon the scoring of a goal (normally a critical goal), all or most of the players of that team scoring the goal leave their bench to congratulate the player who scored. After the first incidence of this situation, notify both teams that any further occurrence by either team will result in a Bench Minor penalty being assessed to that team, under Rule 2.5 (e).*

*Note 2: Obviously a team would be allowed to make a full change of players following the scoring of a goal. The intent of this ruling is to prevent all players from leaving the bench.*

**SITUATION 8 Rule 2.5 (d)**

*Where a team is unable to place the exact number of players on the ice to which they are entitled whether due to penalties or injuries, the Referee shall suspend the game and report this incident to the President.*

**SITUATION 9 Rule 2.5 (g)**

*When a team attempts to make a player change after their allotted time during a stoppage of play and the Referee sends the player back to her bench, thereby giving a warning that any subsequent violation will result in a Bench Minor penalty. This warning applies only to the team committing the infraction. Each team is entitled to one warning during the course of the game, before being assessed a Bench Minor penalty.*

**SITUATION 10 Rule 2.5 (g)**

*A team may send their players for change at different times during a stoppage of play. Defencemen may come first and the forwards slightly later. This is acceptable as long as they respect the procedure and the time guidelines. Only one complete change is acceptable at any one stoppage of play. If a line change is made, and then a timeout is called, further changes can be made. If the Home Team wants to exercise their right of last change, then they must follow this procedure strictly.*

**SITUATION 11 Rule 2.5 (f)****QUESTION:**

*What is meant by “deliberate illegal substitution”?*

**ANSWER:**

*Deliberate illegal substitution occurs when a team intentionally sends extra players onto the ice while play is in progress for the purpose of gaining an advantage, causing a stoppage of play or preventing a goal. Premature (early) substitution during a line change is not a deliberate illegal substitution situation.*

**Rule 2.6 Injured Players**

- (a) When a player, other than a goaltender, is injured or compelled to leave the ice during a game, he must be replaced by a substitute, and play must continue without the teams leaving the ice.
- (b) If a goaltender goes to the players' bench due to an injury, he shall retire from the ice and his place shall be taken by an alternate goaltender and no warm-up will be permitted. However, this will only apply where an alternate goaltender is dressed. In cases where an alternate goaltender is not dressed the injured goaltender will be allowed ten minutes to recuperate. If a replacement is necessary for the injured goaltender, an additional five minutes shall be allowed for a total of fifteen minutes.

The injured goaltender must remain out of the game until the next stoppage of play. For a violation of this rule, a minor penalty for Delay of Game shall be assessed.

- (c) Goaltender replacement shall be subject to the rules governing goaltenders and be allowed the goaltender's full equipment. In Divisions of Pee Wee and below, after a player has been designated as a goaltender, he/she may return to a non-goaltender position. Only in Divisions above Pee Wee, the player must remain as a goaltender once they have been designated as such.
- (d) When a goaltender is injured, players may be permitted to leave the ice at the discretion of the Referee, but must be ready to resume play immediately, on notice by the Referee.
- (e) A penalized player who has to serve a time penalty and who has been injured may proceed to the dressing room, provided he is replaced on the penalty bench by a substitute who was on the ice at the time of the infraction.

A penalized player who does not have to serve a time penalty and who has been injured may proceed to the dressing room without having to be replaced by a substitute on the penalty bench.

For a violation of this rule, a Bench Minor penalty for "Ineligible Player" shall be assessed.

- (f) If an injured penalized player returns to the players' bench before his penalty has expired, he shall take his place in the penalty bench or replace the player substituting for him on the penalty bench during the first stoppage of play. If he takes part in the play before his penalty has expired, he shall be assessed an additional Minor penalty for "Ineligible Player".
- (g) When a player is injured so that he cannot continue play or go to his bench, the play shall not be stopped until the injured player's team has secured possession and control of the puck. If the injured player's team is in possession of the puck at the time of the injury, the play shall be stopped immediately unless his team is in scoring position, at which time the Referee shall allow the play to be completed.

## NEW

*Note 1: Where there is suspicion that a player has sustained serious injury, **any on-ice official** may stop play immediately.*

*Note 2: Where play has been stopped due to an injured player, excluding the goaltender, the injured player shall leave the ice and may not return to the ice until the play has resumed. If the player refuses to leave the ice, a Delay of Game penalty shall be assessed.*

### SITUATION 1 Rule 2.6 (g)

*Note 2: When the Referee stops play because he thinks an injury requires him to do so and then notices that there is no injury, the ruling still applies. This is a judgement call and the player must leave the ice until play resumes.*

### SITUATION 2 Rule 2.6 (g)

*Note 2: Due to an injured player, the Referee stops play. Upon recovering and play resuming, the injured player scores a goal shortly after resumption of play. The injured player did not leave the ice after the stoppage of play, due to his injury. The opposing team appeals to the Referee that the player who scored did not leave the ice.*

**RULING:**

*This player should be classified as being illegally on the ice. Wash out the goal and assess the player a Minor penalty. This ruling would only apply if brought to the attention of the Referee prior to resumption of play following the first stoppage of play after the injury. If brought to the attention of the Referee after the next face-off, then no action would be taken.*

**REASON:**

*As the rule states, the injured player who is responsible for the stoppage of play must leave the ice and not return until play has resumed. Therefore, if he did not leave the ice, he is classified as an ineligible player.*

*Note: This ruling would also apply to any goal scored by the team during this period of time when the ineligible player is on the ice. The Referee should be certain that the player did not leave the ice and then return, before washing out the goal.*

**SITUATION 3 Rule 2.6 (c)**

*A team has only one goaltender dressed and he is injured during the course of the game. A player on the team is given the goaltender's stick, gloves, helmet and proper goaltender facial protection, but does not wish to wear the pads.*

**QUESTION:**

*Can the player be given the full goaltender's privileges even though he is not wearing full goaltender's equipment?*

**ANSWER:**

*YES, as long as the player wears the mandatory goaltender equipment as covered by the rules, helmet, proper facial protection and stick. Rule 3.3 (c), Rule 3.5 and 3.6.*

*Note: Once a player has been given full goaltender's privileges, he cannot return to the game as a player, but must remain classified as a goaltender, even though the regular goaltender is back playing in the game.*

**SITUATION 4 Rule 2.6 (g)**

*As a guideline in the application of this rule, anytime a Trainer comes onto the ice to attend to a player, the player (excluding a goaltender) shall be classified as injured and must leave the ice until play resumes.*

**SITUATION 5 Rule 2.6 (g)**

*At a stoppage of play, it becomes apparent that a player is injured. Play was not stopped as a result of the injury.*

**QUESTION:**

*Does this player have to leave the ice prior to the resumption of play?*

**ANSWER:**

*If the injured player causes a delay in the resumption of play or if the Trainer comes onto the ice, the injured player (excluding a goaltender) must leave the ice until the play resumes.*

**SITUATION 6****QUESTION:**

*A player has a breakaway in the neutral or attacking zone, but the goaltender is apparently hurt. Assuming an injury, the Referee stops the play. What is the ruling?*

**ANSWER:**

*Award a Penalty Shot.*

**SITUATION 7**

*If a Referee notices a player with an open cut, or blood either on the skin, or on the jersey, at the earliest opportunity the Referee should inform the player that the cut must be treated or the jersey changed before the player is eligible to return to the ice. If the player's new jersey has a different number, this should be noted on the score sheet.*

## SECTION 3 EQUIPMENT

### Measurement Guidelines

1. The measurement of any equipment (players' and goaltenders' sticks, goaltenders' pads and gloves) shall be carried out immediately when requested by a team through the Captain or Alternate Captain(s).  
No measurements of any kind will be carried out by the Referee unless a formal request has been made by a team, using the proper procedure.
2. If the complaint for any measurement of sticks or equipment is not sustained, the complaining team will be assessed a Bench Minor penalty.
3. Only one measurement of any kind will be allowed per stoppage of play.
4. Any illegal equipment shall be removed, corrected or adjusted without any unnecessary delay.
5. Where a measurement of a stick is requested by a Captain or Alternate Captain, then she must designate to the Referee what specific part of the stick is to be measured.
6. No goal will be disallowed as a result of any measurement following the scoring of a goal.

#### SITUATION 1

*All measurements are to be conducted at the Referee's crease. Once a determination is made concerning the measurement of a stick or any equipment, the result will be demonstrated at the Referee's crease, only to the Captain (or alternate) of the team to be penalized.*

### Rule 3.1 Adjustment of Equipment

- (a) A Minor penalty shall be assessed any player who delays the game for adjustment of any equipment.
- (b) The onus of maintaining equipment in proper condition shall be upon the player. If adjustments are required, the player must leave the ice and play shall continue uninterrupted, using a substitute.
- (c) A goaltender may not delay the game unnecessarily to adjust his equipment, during a stoppage of play, unless he has received permission from the Referee and remains in the goal area. If a goaltender goes to the players' bench to adjust any equipment he shall retire from the ice and his place shall be taken by the alternate goaltender and no warm-up will be permitted. However, this would only apply where an alternate goaltender is dressed. The alternate goaltender must remain in the game until play resumes. For a violation of this rule, a Minor penalty for Delay of Game shall be assessed.

Note: A goaltender may not go to the player's bench at any time during a stoppage of play unless he is being replaced by a substitute. (Except during a time-out as per rule 10.17 (e) guidelines 3.)

#### SITUATION 1 Rule 3.1 (c)

*If a goaltender asks to go to the bench, he should be informed by the Referee that if he goes, he must be replaced by the alternate goaltender. This applies for either repair of equipment or an injury. If a goaltender requests a towel to wipe his face under the mask, it should be brought to him if the Referee gives permission.*

## SITUATION 2 Rule 3.1 (c)

## QUESTION:

*Can a Trainer attend an injured goaltender who is in his crease, without the goaltender having to retire from the ice and his place taken by the alternate goaltender?*

## ANSWER:

*Yes. The Trainer must first receive permission from the Referee, before he can leave the bench and go on the ice.*

## SITUATION 3 Rule 3.1 (c)

## QUESTION:

*Can a Referee give a goaltender permission to go to the bench to adjust his equipment or to recover from an injury, then permit that goaltender to return to the game, even though the team has a substitute dressed and on the bench?*

## ANSWER:

*No.*

## SITUATION 4 Rule 3.1 (c)

## QUESTION:

*On a stoppage of play, the Referee notices that the goaltender is at the players' bench. He notifies the team that they must replace the goaltender with the substitute goaltender. Can the team choose to keep the original goaltender in the net and take the Minor penalty?*

## ANSWER:

*Yes.*

## SITUATION 5 Rule 3.1 (c)

*Note: A delayed penalty is signaled against Team "A". Team "B" goaltender proceeds to his players bench.*

## RULING:

*1) If the goaltender substitution has not been completed when play is stopped, the goaltender must not continue to the players' bench, unless he is within the 3.05m (10 ft.) area of his players bench.*

*2) In situations of penalties after the whistle, the goaltender must not proceed to the players bench.*

*Officials are encouraged to intervene prior to the goaltender getting to the players' bench. Thus avoiding having to penalize the goaltender or having to be replaced by the substitute goaltender.*

## SITUATION 6 Rule 3.1 (c)

*A team requests that the pads of the opposing goaltender be measured by the Referee. The Referee, who measures the pads in the Referee's crease, finds them to be illegal and assesses the Minor penalty under Rule 3.5 (c).*

## QUESTION:

*Since the goaltender is permitted to continue to wear such pads provided they are adjusted to the correct measurements, can that goaltender go to his players' bench to correct the size of the pads, without having to be replaced by the substitute?*

## ANSWER:

*Yes. Since the pads are illegal, the Referee is in fact actually ordering the goaltender to correct the pads. Under this condition only, the substitute does not have to replace the regular goaltender, provided the pads can be corrected without undue delay.*

**SITUATION 7 Rules 3.1 (a) and 3.1 (c)**

*Where a goaltender goes to the bench during a stoppage of play and then returns to his goal, a Minor penalty for Delay of Game shall be assessed under this rule. The penalized goaltender shall now be allowed to stay in the game.*

**SITUATION 8**

*A team may place a plastic water bottle on top of the net for use by the goaltender. This bottle does not have to be fastened to the goal frame. If the goaltender (or any other player) deliberately throws the bottle on the ice, then the appropriate penalty (penalties), as prescribed by the rules, shall be assessed.*

**Rule 3.2 Broken Sticks**

- (a) A player or goaltender without a stick may participate in the game. A player or goaltender whose stick has been broken must drop the broken portions to the ice immediately. A Minor penalty shall be assessed for an infraction of this rule.

*Note: When a player discards the broken portions of a stick by tossing them to the side of the rink (not over the boards) in such a way that they do not interfere with play or opposing players, no penalty shall be assessed.*

- (b) A player who has lost or broken her stick may only receive another stick at her own players' bench or be handed one from a teammate on the ice, and may not receive a stick thrown on the ice from any part of the rink. A Minor penalty shall be assessed for an infraction of this rule.

*Note: A player tendered a stick from the bench (players' or penalty) thrown on the ice, who does not pick up the stick, will not receive a penalty. The person responsible for throwing the stick will receive a penalty, as covered in Rule 7.3 (d) - Interference.*

- (c) A goaltender who breaks or loses her stick may use a stick of a player handed to her by a player until the next stoppage of play. In this case the players' stick will not be considered an illegal stick. A goaltender may not continue to play with a broken stick of any kind.
- (d) A goaltender may receive a stick from a teammate without proceeding to her player's bench providing the stick is handed to her. A goaltender receiving a stick illegally shall be assessed a Minor penalty.
- (e) A goaltender may not go to the players' bench during a stoppage of play for a replacement of her stick, but must receive her stick from a teammate. For a violation of this section, a Minor penalty for Delay of Game shall be assessed the goaltender.

**SITUATION 1 Rule 3.2 (b)****QUESTION:**

*A player on the penalty bench hands a stick to a teammate on the ice, whose stick has been broken. What is the penalty?*

**ANSWER:**

*The player receiving the stick would be assessed a Minor penalty for "illegally receiving a stick". The player in the penalty box handing the stick to the player on the ice would not be assessed any penalty.*



**SITUATION 2 Rule 3.2 (b)**

*A player without a stick picks up a stick thrown to her on the ice from her players' bench. This player is to be assessed a Minor penalty for "illegally receiving a stick". If the person (player or team official) throwing the stick is identified by the Referee, she shall be assessed a Bench Minor and Game Misconduct, under Rule 7.3 (d) – Interference. If the person (player or team official) throwing the stick is not identified by the Referee, a Bench Minor penalty shall be assessed to the Team responsible for such action, under Rule 7.3 (c) – Interference. If the player on the ice does NOT pick up the stick, then she would not be assessed a penalty, but the action of throwing the stick on the ice from the bench would still be penalized as described above.*

**SITUATION 3 Rule 3.2 (b)**

*A player of Team "A" who has broken her stick picks up a stick thrown from the bench of Team "B", intended for a player of Team "B" who has also broken her stick.*

**QUESTION:**

*What penalties are assessed?*

**ANSWER:**

*The player of Team "A" who picks up the stick shall be assessed a Minor penalty for "illegally receiving a stick". Team "B" shall also receive a Bench Minor penalty if the Referee is unable to identify the player or team official who threw the stick on the ice. Should the Referee be able to identify the player or team official who threw the stick on the ice then they shall be assessed a Bench Minor and Game Misconduct.*

**SITUATION 4**

*Where a player with a stick in her hands shoots a broken stick on the ice at an opposing player and hits the opponent or interferes with her progress, whether or not she has the puck, assess a Minor penalty for interference, under Rule 7.3 (a)(1). If the player is injured by the broken stick, assess a Major and Game Misconduct for interference, under Rule 7.3 (e). A Match penalty may be assessed if, in the opinion of the Referee, there was either deliberate injury or deliberate attempt to injure.*

**SITUATION 5 Rule 3.2 (b)(d)**

*If a player on the ice shoots the stick back to a player or goaltender who has lost her stick and by doing so interferes with the play or opposing players in any manner, that player shall be assessed a Minor penalty, for interference, under Rule 7.3 (a)(1). If a player on the ice shoots the stick back to a player or goaltender who has lost her stick and by doing so does not interfere in any manner with the play or opposing players, no penalty shall be assessed (this rule is consistent with the guidelines for kicking a stick back to a teammate as found in Rule 9.8, Situation 4). If the player or goaltender who lost her stick picks up the stick shot at her, that player or goaltender shall not be assessed a penalty.*

**SITUATION 6 Rules 3.2 (a)(b)**

*No. 6 of Team "A" has lost or dropped her stick. No. 10 of Team "A" hands her stick to No. 6. After a period of time, with play still in progress, No. 6 hands the stick back to No. 10 who has still not received another stick. This is perfectly legal. Following this second exchange of sticks, No. 6 picks up her stick which is lying on the ice.*

**RULING:**

*No penalty to No. 6.*

**REASON:**

*The only player who can pick up the stick on the ice and use it to participate in the play*

is the original player who dropped it, regardless if she has played with another stick in the meantime.

**SITUATION 7** Rule 3.2 (a)(b)

**QUESTION:**

Is there a limit to the number of times that sticks can be exchanged from player to player on the ice where one player is participating without a stick?

**ANSWER:**

No.

**SITUATION 8** Rule 3.2 (c)

A goaltender who breaks or loses her stick will be allowed to play with a regular players' stick only until the next stoppage of play. The player's stick must be handed to the goaltender according to the rules (see Rule 3.2, Situation 11). The goaltender will be compelled to obtain a regular goaltender's stick at the first stoppage of play.

**SITUATION 9** Rule 3.2 (d)

**QUESTION:**

A goaltender has lost her stick in the corner. Can any defending player pick it up and bring it back to the goaltender, without being assessed a penalty?

**ANSWER:**

Yes, as long as that player does not participate in the play while carrying the goaltender's stick. See Rule 3.3 (a), Situation 3.

**SITUATION 10** Rule 3.2 (d)

A player carrying a goaltender's stick to a goaltender who has lost or broken her stick, decides to become involved in the play. The player drops the goaltender's stick and participates in the play.

**RULING:**

Assess the player a Minor penalty for interference. Once the player makes the commitment to carry the stick to the goaltender, she must follow through with that commitment. As long as she in no way participates with the play, no penalty would be assessed for carrying the stick to the goaltender, even though the player may be in the vicinity of the play.

**SITUATION 11**

**QUESTION:**

A goaltender breaks her stick. A player of the same team gets a stick at the players' bench and in the act of taking the stick to the goaltender, the player slides the stick along the ice to the goaltender. Is that considered legal?

**ANSWER:**

No. A goaltender may receive a new goaltender's stick without proceeding to the players' bench. A player may carry a new stick back to the goaltender. After receiving a new goaltender's stick from the bench, the player may not throw or slide the stick along the ice but must carry the stick back to the goaltender and hand it to her. A player who slides or throws a stick to the goaltender is to be assessed a Minor penalty under Rule 9.8 (c) – Throwing Stick. A Penalty Shot may be awarded under Rule 9.8 (a) if the player throws the stick at the puck or puck carrier in her defending zone. If the goaltender picks up the stick, she shall be assessed a Minor penalty, for "illegally receiving a stick". No penalty is to be assessed against the goaltender in the above situation if she does not pick up the stick. If the player interferes with an opposing player or the puck while carrying the extra stick, she shall be assessed a Minor penalty for using an "illegal stick", under Rule 3.3 (d) – Sticks.

**Rule 3.3 Sticks**

The intent of this rule is to only permit the use of conventional sticks. Any special changes, deviations or innovations require review and approval by Hockey Canada's Board of Directors.

- (a) All sticks (including goaltenders' sticks) may be made of wood, fibreglass or aluminum and/or any other material approved by Hockey Canada's Board of Directors. They must not have any projections, pockets, netting or other similar contrivance designed to give the player or goaltender undue assistance in the playing of the game.
- (b) The stick shall not exceed 1.60m (63 in.) from the heel to the end of the shaft, and 31.75cm (12 1/2 in.) from the heel to the end of the blade. The blade of the stick shall not be less than 5.08cm (2 in.) (within 1.27cm (1/2 in.) of the end) nor greater than 7.62cm (3 in.) in width.
- (c) The goaltender's stick shall not exceed 1.4m (55 in.) from the heel to the end of the shaft. The blade of the goaltender's stick shall not exceed 8.89cm (3 1/2 in.) in width at any point nor be less than 7.62cm (3 in.), except at the heel where it must not exceed 11.43cm (4 1/2 in.) in width; the goaltender's stick shall not exceed 39.37cm (15 1/2 in.) in length from the heel to the end of the blade. The width portion of the goaltender's stick extending up the shaft from the blade shall not exceed 66.04cm (26 in.) in length, calculated from the heel, and shall not exceed 8.89cm (3 1/2 in.) nor be less than 7.62cm (3 in.) in width.
- (d) A Minor penalty shall be assessed any player, including the goaltender, for using a stick which does not conform to the provisions of this rule.
- (e) The end of the shaft of all sticks must be covered to protect against injury. In the case of hollowed shaft sticks, the end of the shaft must have a protective cap as well as being covered to protect against injury. A player may carry only one stick while participating in the play.  
A Minor penalty for Ineligible Player shall be assessed to any player who participates in the play while carrying more than one stick.
- (f) A Minor penalty and a Misconduct penalty shall be assessed any player who deliberately breaks a stick when asked to produce the same stick for measurement or who refuses to surrender her stick for measurement.
- (g) When requested, the Referee shall take the stick to be measured to the Referee's crease at the penalty bench, where the appropriate measurement will be made using a tape measure or stick gauge.
- (h) The stick may be wound with any colour tape.

**SITUATION 1 Rule 3.3 (b)**

*The Referee should not measure the stick of any player on the penalty or players' bench, but must wait until the player comes onto the ice. If a player on the ice has her stick measured and it is found to be illegal, she is to be assessed a Minor penalty for "Illegal Equipment". It does not matter whether or not she has participated in the play to this point. The significant fact is that she is on the ice with an illegal stick. If a player whose stick is about to be requested for measurement goes to her bench and throws or deposits her stick at the bench, or stays there, before being officially requested to submit her stick, but the Referee or Linesman does not lose sight of the stick, it can still be measured. No Misconduct may be assessed until the player has been formally requested to submit her stick. Note: A Referee is to measure only one stick or piece of equipment during a stoppage of play. This does not*

mean per team, but only one measurement per stoppage of play. There is not a stick curvature measurement limitation to be enforced (See also Rule 3.7 Situation 1).

**SITUATION 2 Rule 3.3 (a)**

*Any player carrying a stick back to the goaltender, in addition to carrying her own stick, who participates in the game by playing the puck or who interferes with an opposing player, shall be assessed a Minor penalty for "Ineligible Player". Also see Rule 3.2 (d) Situations 9, 10, and 11.*

**SITUATION 3 Rule 3.3 (a)**

**QUESTION:**

*Can a player on the ice carry two players' sticks so that she can give one to a teammate who has lost or broken her stick?*

**ANSWER:**

*No. A Minor penalty shall be assessed, whether or not the player becomes involved in the play. The penalty shall be assessed for playing with two hockey sticks.*

**SITUATION 4 Rule 3.3 (d)**

*A goaltender loses her stick and a teammate hands the goaltender her own stick. The player meanwhile picks up the goaltender's stick and plays with it.*

**RULING:**

*Assess the player a Minor Penalty for "Illegal stick". No penalty would be assessed to the goaltender. Rule 3.2 (c).*

**SITUATION 5 Rule 3.3 (h)**

*This means that any color or combination of colors may be used.*

**SITUATION 6 Rule 3.3 (a)**

*Please note that Hockey Canada has approved the use of the "UB Offset" players stick and the "Curtis Curve" goaltenders stick.*

## **Rule 3.4 Skates**

- (a) Hockey skates shall be of a design approved by Hockey Canada's Board of Directors. No player or goaltender may participate in the game unless he is wearing skates.
- (b) The use of speed skates, figure skates or any skates that may cause injury are prohibited.
- (c) An official or player, other than a goaltender, shall not use goaltenders' skates.

## **Rule 3.5 Goaltender's Equipment**

- (a) With the exception of skates and stick, all equipment worn by the goaltender must be constructed solely for the purpose of protection of the head or body, and must not include any garment or contrivance which would give the goaltender undue assistance in keeping goal. Abdominal aprons extending down the thighs on the outside of the pants are prohibited.

*Note 1: Protective padding attached to the back of, or forming part of the goaltender's blocker glove shall not exceed 20.3 cm (8 in.) in width nor 38.1 cm (15 in.) in length. Any measurement exceeding 20.3 cm (8 in.) measured anywhere across the*

full length of the wrist area, or more than 38.1 cm (15 in.) anywhere on the length constitutes an illegal blocker glove.

*Note 2: The base of the goaltender's catching glove shall be restricted to a maximum of 20.32 cm (8 in.) in width, which is to include any attachments added to that glove. The distance from the heel of the glove along the pocket and following the contour of the glove to the top of the "T" trap must not exceed 46 cm (18 in.) The heel is considered to be the point at which the straight vertical line of the cuff meets the glove. Any measurement exceeding 20.32 cm (8 in.) measured anywhere across the full length of the wrist area. The maximum circumference of the legal goaltenders catching glove can not exceed 114.3 cm (45 in.) (see Appendix "B" for diagram). The lacing or webbing or other material joining the thumb and index finger of a goaltender's glove, or any cage, pocket or pouch created by this material, must not exceed the minimum amount of material necessary to fill the gap between the thumb and the index finger when they are fully extended and spread. Any other pocket, pouch or contrivance added to the glove by a manufacturer or otherwise is not acceptable and makes the glove illegal.*

*Note 3: The binding and/or stitching at the edges of both goaltender's gloves shall not be included in the measurement of either the length or width.*

*Note 4: When a request for a measurement of a goaltender's glove has been made the team shall state the glove that is to be measured and whether it is to be the length or width of the glove.*

- (b) Goaltender's pads, shall not exceed 27.94 cm (11 in.) in width and 96.52 cm (38 in.) in length as measured on the goaltender and shall not be altered in anyway. The minimum length of the boot of the pad is to be no less than 17.78 cm (7 in.). The boot is the bottom of the pad that sits over the top of the skate. The boot channel of the goalkeeper pad must be flat or concave in appearance.

*Note: Puck foil (a plastic piece attached to the bottom of goaltender's pads designed to stop the puck) is considered to be illegal equipment.*

- (c) A Minor penalty shall be assessed a goaltender guilty of using or wearing illegal equipment.
- (d) A goaltender shall remove her face protector for purpose of identification, if so asked by the Referee. A goaltender who refuses this request shall be assessed a Gross Misconduct penalty.

## **Chest and Arm Pads**

1. No raised ridges are allowed on the front edges or sides of the chest pad, the inside or outside of the arms, or across the shoulders.
2. Layering at the elbow is permitted to add protection but not to add stopping area. This layering, both across the front and down the sides to protect the point of the elbow shall not exceed 17.78 cm (7 in.).
3. Shoulder Cap Protectors must follow the contour of the shoulder cap without becoming a projection/extension beyond or above the shoulder or shoulder cap. This contoured padding must not be more than 2.54 cm (1 in.) in thickness beyond the top ridge of the shoulder and shoulder cap.

4. On each side, the Shoulder Clavicle Protectors are not to exceed 17.78 cm (7 in.) in width. Their maximum thickness is to be 2.54 cm (1 in.) This protection is not to extend or project above or beyond the shoulder or shoulder cap nor extend beyond the armpit. No insert is allowed between the Shoulder Clavicle Protector and the chest pad that would elevate the Shoulder Clavicle Protector.
5. If when the goalkeeper assumes the normal crouch position, the shoulder and/or shoulder cap protection is pushed above the contour of the shoulder, the chest pad will be considered illegal.

**SITUATION 1 Rule 3.5 (b)(c)**

*If a measurement of the goaltender's pads is required during the course of the game, this measurement should be carried out by the Referee in the Referee's crease. Both pads are to be measured. The measurement may take place anywhere across the width of the pads. The measurement is made with the pads on the goaltender and she shall be allowed 4 hits on each pad to bring them into alignment. The measurement is to be taken with the goaltender in the standing position and the pads not contacting any fixed object. This measurement is taken by extending a tape measure at right angles from the outer edge of each pad at its widest point. The measurement may be taken anywhere throughout the length of the goaltender's pad.*

**SITUATION 2**

*When a goaltender's pads are measured and found to be illegal, the goaltender will be penalized, and shall:*

1. *remove and change the pads or,*
2. *tape or tie the pads in a manner that they conform to the measurement required. The goaltender shall be assessed another Minor penalty if the opposing team requests another measurement and the pads are again found to be illegal. If, following this second Minor penalty, the goaltender refuses to change or adjust the pads when ordered to do so by the Referee, she shall be assessed a Gross Misconduct.*

**SITUATION 3 Rule 3.5 (a)**

*Note 1: Goaltender's blocker*

*Note 2: Goaltender's catching glove. The measurement of the goaltender's blocker or catching glove shall be carried out by the Referee at the Referee's crease. The binding and/or stitching at the edges shall not be included in the measurement of width nor length. The measurement to be made must be specified, whether it is the width or the length to be measured. Keep in mind only one measurement per stoppage. The blocker is measured with it being removed and it will include the distance of the curvature. The measurement shall be a direct line from the one edge, measured at right angles to the opposite edge. This measurement may be anywhere between the two edges and should include the widest point, following any curvature of the blocker. The catching glove is measured with it being removed. The glove is allowed to retain the shape that it has developed when being worn by the goaltender and shall not be flattened. The length measurement will not include the depth within the webbing or pocket, it shall be a direct line from the bottom edge, measured at right angles to the top edge, which is a line to the furthest point of the mitt from the base of the glove. The width measurement is made at right angles to the opposite edge across the cuff area only.*

*Note: See Appendix "B" - Goaltender Gloves and Pads.*

**Rule 3.6 Protective Equipment**

- (a) All protective equipment except gloves, head gear or goaltenders' leg pads, must be worn entirely under the uniform. Leather elbow patches on the outside of the sweater and palmless gloves are prohibited. After one warning by the Referee, a Minor penalty for Illegal Equipment shall be imposed on the offending player for any subsequent violation of this rule.
- (b) While on the ice, including pre-game warmups, all players, including goaltenders, shall wear a CSA certified hockey helmet, to which a CSA certified facial protector must be securely attached and not altered in any way. Any alteration to a CSA certified helmet or facial protector automatically destroys the certification.

The chin straps of the helmet shall be securely fastened under the chin. The straps of the facial protector, when designed to allow such straps, shall also be securely fastened to the hockey helmet.

For violations during pre-game warmups, the Referee shall report the infraction on the official game report to the President.

It is mandatory that players purchasing new facial protectors follow these guidelines:

*Note 1: Types B1, B2, 2, D1, D2 and 3 differ from Types A, B and C only in the penetration requirements in Clause 4.3.3 of the CSA standard. Players shall remove their helmet during the playing of the national anthem(s).*

*Note 2: The wearing of a CSA certified facial protector or visor for players registered with Senior(recommended but optional for male adult recreational hockey) and Junior hockey teams shall be compulsory. In all divisions of Female Hockey, the wearing of a CSA certified facial protector shall be compulsory.*

*Note 3: Goaltenders in all divisions of hockey shall be required to wear a CSA certified hockey helmet to which a CSA certified facial protector has been securely attached and not altered in any way.*

*Note 4: All players while on the players' and/or penalty bench must wear their certified helmet and facial protector securely attached. Any goaltender on the bench, as a minimum, is required to properly wear the same protective head equipment as the players. For a violation of this section of the rule, a warning shall be issued to the team. The second and subsequent violations by the same team will result in a Minor penalty being assessed against the offending team.*

CATEGORY	DESCRIPTION	TYPE	CSA STICKER COLOUR
Full-Face protectors	Players older than 10 years of age (other than goalkeepers)	B1 or 1	White
		A	Green
	Players older than 10 years of age and younger (other than goalkeepers)	B2 or 2	Orange
		B	Red
	Goalkeepers of all ages	D1, D2 or D3	Blue
		C	Purple
Eye protectors (visors)	Players in the major junior age category and older (other than goalkeepers)	C or 4	Yellow

- (c) Should the helmet of a player come off while play is in progress, such player shall replace the helmet (properly fastened) or shall proceed to the players' bench for a substitution. If such a player participates in the play in any manner without his helmet, the play must be stopped immediately and the player assessed a Minor penalty. The penalty shall be assessed for participating in the play without the proper protective equipment and recorded on the Official Game Report as "ineligible player".

When a goaltender loses his helmet and/or facial protector, play shall be stopped immediately. Any such deliberate action by the goaltender shall result in a Minor penalty for "Delay of Game". If this deliberate action (by a player or goaltender) occurs when an opponent is on a breakaway in the neutral or attacking zone, or occurs during the last two minutes of regular playing time, or any time in overtime, a Penalty Shot

**NEW**

shall be awarded to the non-offending team. **Any player or players who remove their helmets or undo their chinstraps before or during fights will be assessed a Gross Misconduct penalty.**

**If a player intentionally removes his helmet or intentionally releases his chinstrap to fight and the opposing player doesn't, the former will be assessed an additional two-minute penalty in addition to the Gross Misconduct.**

**If the player removes his opponent's helmet or releases his opponents chinstrap before or during a fight, a Gross Misconduct penalty will be assessed.**

- (d) Where a player wears a helmet and/or facial protector in an offset position during play. The team shall receive one warning and any subsequent infractions by the same team will result in a Misconduct penalty assessed to that player.
- (e) If the Referee's attention is drawn to the possibility that a facial protector or helmet may not be CSA certified, or if the Referee observes that a facial protector or helmet may not be certified, and should that piece of equipment in effect turn out not to be certified, the Referee shall assess a Minor penalty and at the same time order that illegal piece of equipment removed from the game.

*Note 1: The Referee is empowered to make the call without his attention being drawn by an opposing player or team official, through the Captain.*

*Note 2: The Referees' Case Book contains detailed procedures to follow in the case of a player having to serve a penalty for a non-certified helmet or facial protector.*

- (f) The wearing of a BNQ approved throat protector is compulsory for players registered in minor and female hockey. When a player fails to wear or properly wear a throat protector at any time on the ice during the game, the team shall receive one warning and any subsequent infractions by the same team will result in a Misconduct. Referees are encouraged to deliver this warning directly to the coach.
- (g) For divisions of hockey that allow the wearing of the half visor, the wearing of a mouth guard is compulsory (recommended but optional for Senior hockey). When a player fails to properly wear a mouth guard at any time on the ice during the game, his team shall receive one warning. Any player on that team who commits a subsequent infraction will receive a Misconduct penalty. Referees are encouraged to deliver this warning directly to the Coach.



## CLARIFICATIONS

1. If a player undoes his chin strap in order to incite or challenge an opponent, that player shall be assessed a Misconduct under Rule 9.2(e).
2. If a player undoes his own chin strap for any reason including the intention to challenge or incite an opponent to fight and this player loses the helmet during the fight, that player shall be assessed a Gross Misconduct. No Misconduct would be necessary in this case.
3. If neither player removes the helmet or undoes the chin strap prior to the fight, but the helmets come off during the fight, one of three situations are possible:
  - a) If the Referee determines that the helmet(s) came off incidentally during the fight, no penalties under Rule 3.6(c) need to be assessed.
  - b) If the Referee determines that a player deliberately pulled his opponent's helmet off during the fight, the Referee shall assess the Minor Penalty or at the discretion of the Referee a Major and a Game Misconduct penalty for grabbing an opponent's helmet under Rule 6.1 (d).
  - c) If a player grabs the opponent helmet or facial protector and uses this to gain an advantage or to inflict punishment or injury, the Referee shall assess a Match Penalty under Rule 6.1 (d).
4. If players undo each others' chin straps and/or remove each others' helmets prior to the start of the fight in an effort to circumvent this rule, the Referee shall assess both players Gross Misconduct penalties, plus any other penalties that they incur, under Rule 4.7 (b) for making a "travesty of the game".

## SITUATION 1 Rule 3.6 (c)

*If a player loses his helmet, facial protector, throat protector, or his chinstrap becomes undone while play is in progress, that player has two (2) options:*

1. *Replace his helmet, facial protector, throat protector, or his chinstrap and properly fasten it before participating in the play or,*
2. *Proceed to the players' bench and be substituted for, in accordance with the rules. If a player participates in the play without his helmet, facial protector, throat protector, or without his chinstrap fastened, play shall be stopped immediately, regardless of which team is in possession of the puck and the offending player shall be assessed a Minor penalty for "Ineligible Player".*

*Note: THIS IS NOT A DELAYED PENALTY.*

## SITUATION 2 Rule 3.6 (b)

*If during the course of a game a player is checked or hit with the result that one of the side straps holding the facial protector comes undone, but the chin strap remains secure, it is not necessary to assess a penalty. The player should be notified at the first stoppage of play.*

## RATIONALE:

*It may not be obvious to the player that the side strap has come undone, therefore no penalty is assessed. However, if the chin strap is also undone or if the facial protector is flapping in a manner that would attract the players attention, then a Minor penalty is assessed.*

## SITUATION 3 Rule 3.6 (b)

*In cases where a players chin strap is not securely fastened, or the visor is not properly being worn, the Referee or Linesman shall remove the player(s) from the ice prior to the*

*commencement of play. Only that player or players shall be allowed to be substituted. This same procedure would also apply concerning other items involving protective or dangerous equipment. (Example - sweater sleeves pulled up, exposing elbow pads.) Note: The proper wearing of a visor: The visor shall extend down to cover the eyes and the lower edge of the nose in frontal and lateral projections.*

**SITUATION 4 Rule 3.6 (c)**

*A player loses his helmet and due to an apparent injury, is unable to properly replace the helmet or go to the players' bench.*

**RULING:**

*Stop play immediately, regardless of which team is in possession of the puck. No penalty would be assessed to the player under this rule. This situation supersedes Rule 2.6 (g) - Injured Players - where play is allowed to continue. The injured player would still be required to leave the ice and may not return until play has resumed. If the player was on a breakaway in the neutral or attacking zone, the Referee would follow the same procedure and shall award a Penalty Shot to the player deprived of a scoring opportunity.*

*Note: This interpretation also applies to facial and throat protectors.*

**SITUATION 5 Rule 3.6 (c)**

*A player is on a breakaway in the neutral or attacking zone and a player of the opposing team loses his helmet while trying to check him. The Referee must let the play continue and watch what the defending player does. If the player without the helmet puts it back on (properly fastened) or goes to his bench, the Referee shall allow the play to go on. If the player without the helmet gets up and chases the player on the breakaway, the Referee must stop play immediately and award a Penalty Shot, as per Rule 7.4 (c) - Tripping. If the goaltender had been removed for an extra attacker, the Referee would award a Goal, as per Rule 4.10 (a)(3) - Awarded Goals. In either case, this infraction would be classified as "fouling from behind". Note: This interpretation also applies to facial protectors and throat protectors.*

**SITUATION 6 Rules 3.6 (c) and 4.9 (c)**

*A player is on a breakaway in the neutral or attacking zone and a player of the opposing team deliberately removes his helmet in an effort to get a stoppage of play.*

**RULING:**

*The Referee shall award a Penalty Shot to the player deprived of a scoring opportunity. This interpretation also applies to facial protectors and throat protectors.*

**SITUATION 7**

*A goaltender intentionally removes his helmet, facial protector or throat protector during the course of a Penalty Shot.*

**RULING:** Award a goal.

**SITUATION 8 Rule 3.6 (a)**

*With reference to palmless gloves: the intent of this rule is to prohibit the use of gloves where the palm has been intentionally removed or cut out to permit the use of bare hands. Where the palms are worn with some holes resulting, such gloves are permissible unless, in the Referee's opinion, the holes are of such a size that the player can take advantage by being able to use the bare hands to hold an opponent.*

**SITUATION 9 Rule 3.6 (e)**

*Where a Captain requests the Referee to check or certify the validity of a helmet, facial protector or throat protector worn by an opposing player and the equipment in question is*

found to be certified, no penalty shall be assessed to the complaining team. The checking or verification of a helmet, facial protector or throat protector is not classified as a measurement.

**SITUATION 10 Rule 3.6 (e) Note 2**

Where a player has been assessed a Minor penalty for wearing a non-certified helmet, facial protector or throat protector, such player shall not be permitted to take his place on the penalty bench until he has obtained a certified helmet, facial protector or throat protector, as the case may be. This entails that a substitute (player on the ice at the time of the infraction) must replace the penalized player on the penalty bench immediately. If the penalized player can obtain a certified helmet, facial protector or throat protector without delaying the game in any manner, he may then serve his penalty. Otherwise, a substitute will have to replace him on the penalty bench. A procedure similar to that explained in Rule 2.6 (e)(f) - Injured Players - will then be in force. If the penalized player obtains a certified helmet, facial protector or throat protector before his penalty has expired, he shall replace the player substituting for him on the penalty bench during the next stoppage of play. If that penalized player takes part in the play before his penalty has expired, he shall be assessed an additional Minor penalty for "Ineligible Player".

**SITUATION 11 Rule 3.6 (e)**

Where a player is required to wear a certified helmet, facial protector or throat protector, and more than one is found to be non-certified, only one Minor penalty shall be assessed during the same stoppage of play.

**SITUATION 12 Rule 3.6 (e)**

If, after a player has been assessed a Minor penalty for wearing a non-certified helmet, facial protector or throat protector, and that player refuses to change the illegal piece of equipment, the Referee shall assess a Gross Misconduct.

**SITUATION 13 Rule 3.6 (e) and Rule 3.6 (e) Note 1**

At any time prior to the start of a game, a Referee may notify a team of an illegal piece of equipment, advising them to correct it or change it before the initial face-off. For example, a Referee observes a player or goaltender wearing a non-certified helmet or facial protector during the pre-game warm-up. The Referee may then, without assessing a penalty notify the player or team that such equipment is not permissible. This may be done without penalty only prior to the start of the game.

**SITUATION 14 Rule 3.6 (b) Note 1**

If a player is listed on the Official Game Report as an affiliated player (AP) and you notice that he is not wearing an approved full facial protector and/or a BNQ approved throat protector, check with a team official, if possible, to find out which division the player graduated from. If the player is from Minor Hockey, the player should now be requested to wear a CSA certified full facial protector and BNQ approved throat protector. No penalty would be assessed at this point provided this occurs prior to the start of the game. If the game has started, assess a Minor penalty for "Illegal Equipment". If, after the request has been made, the player refuses to wear a CSA certified full facial protector or BNQ approved throat protector, he shall be assessed a Gross Misconduct. This situation must be rectified prior to the resumption of play. In any event, a report shall be made by the Referee anytime an affiliated player (as identified on the Official Game Report) is not wearing a CSA certified full facial protection or BNQ approved throat protector. This would include cases where the Referee has been notified by the team that the player in question is not a Minor Hockey affiliate.

**SITUATION 15 Rule 3.6 (b) Note 4**

*It is acceptable for a player while on the players' bench to raise his mask to take a drink or to remove his helmet to clean the visor or for repairs. It must be replaced properly as soon as possible.*

**SITUATION 16 Rule 3.6 (b) Note 4**

*Where rinks have a glassed in penalty bench it is acceptable for players to remove their helmets and/or masks.*

**SITUATION 17**

*The Canadian Standards Association (CSA) has set the established standard for hockey helmets and facial protectors in Canada. Helmets and facial protectors used within Hockey Canada must display the "CSA" identification.*

**SITUATION 18**

*The Bureau de Normalization du Quebec (BNQ) has set the established standard for hockey throat protectors in Canada. All throat protectors used in Minor and Female Hockey within Hockey Canada must display the "BNQ" identification.*

**SITUATION 19**

*Hockey Canada requires all players and goaltenders to wear helmets that are CSA certified from the manufacturer. It is the responsibility for the equipment user to ensure that throughout the life of the helmet, the CSA certification is maintained. Hockey Canada advises that prior to applying anything to the helmet including stickers that they refer to the manufacturer's instructions and if applicable, the manufacturer to confirm the type of adhesive they are applying will not jeopardize CSA certification and/or the manufacturer's warranty. It is the sole responsibility for the equipment user to ensure they are not applying adhesives or other materials that may affect the integrity of the helmet and ultimately void the CSA certification and/or manufacturer's warranty. Officials are NOT to make any decision with regards to the application of stickers on helmets and its effect on CSA certification.*

**SITUATION 20 Rule 3.6 (b) & (f)**

*A goal is scored by Team "A" and the Referee notices or Team "B" directs the Referees' attention to the fact that the Team "A" player that scored the goal is not wearing a CSA certified helmet or facial protector (and/or throat protector in minor or female hockey), or the chinstrap is undone.*

**RULING:**

*The goal is allowed and the appropriate penalty is assessed to the offending player on Team "A".*

**SITUATION 21 Rule 3.6 (b) & (f)**

*Where a player is wearing the throat protector in a manner that is careless or clearly not within intended guidelines, the team shall receive one warning and any subsequent infractions by the same team will be penalized immediately under Rule 3.6 (f). Referees are encouraged to deliver this warning directly to the coach.*

**SITUATION 22 Rule 3.6 (f)**

*Goaltenders in Minor or Female hockey who wear an attachment to the mask or helmet designed to protect the throat, must still wear a BNQ approved throat protector.*

**SITUATION 23 Rule 3.6 (g)**

*Where a player is wearing the mouth guard in a manner that is careless or clearly not within intended guidelines, the team shall receive one warning and any subsequent infractions by the same team will be penalized immediately under Rule 3.6 (g). Referees are encouraged to deliver this warning to the coach.*

**SITUATION 24**

*Goaltenders in all divisions of hockey shall be required to wear a CSA certified hockey helmet to which CSA certified facial protector has been securely attached and not altered in any way. In cases where a goaltender is wearing a combination facemask/helmet, the helmet portion shall completely cover the head. When the referee deems such a mask/helmet not safe, he may request the goaltender to change it.*

**Rule 3.7 Dangerous Equipment**

- (a) The use of pads, protectors or sticks likely to cause injury to a player are prohibited.
- (b) No player is permitted to wear a sweater or pants modified or altered to gain an advantage or compromise safety.
- (c) All elbow pads which do not have a soft protective covering of sponge, rubber or a similar material at least 1.27cm (1/2 in.) thick shall be considered dangerous equipment.
- (d) The use of supplemental oxygen is prohibited.
- (e) For a violation of this rule a warning shall be issued to the team. Any subsequent violations to any player on the same team shall result in a Minor penalty to the offending player.

*Note: The Referee has the authority to prohibit a player from participating in the game while using or wearing any equipment that she considers dangerous to a player or game official.*

**SITUATION 1 Rule 3.7 (a)(e)**

*Where a player is using a stick that has a large knob taped down from the end of the shaft so that, while she is playing with this stick, there is a considerable part of the butt-end sticking out beyond her upper glove, this should be classified as dangerous equipment, even though the player is in no way using this part of the stick. Note: The Referee has the authority to remove any stick from the game, deemed dangerous by way of its curvature without a penalty being assessed.*

**SITUATION 2 Rule 3.7 (a)**

*A goal is scored and the official or opposing team notices that the player who scored the goal is wearing goaltenders' skates.*

**QUESTION:**

*Do you allow the goal?*

**ANSWER:**

*Yes, the goal is allowed. The Referee should notify that player that if she comes on the ice again wearing those skates, she shall be assessed a Minor penalty under Rule 3.7 (e). A similar decision would apply if the player involved had received an assist on the goal. See Rule 3.4 (c).*

**SITUATION 3 Rule 3.7 (e)**

*Where a player has been assessed a Minor penalty under this rule for the use of dangerous equipment, it means that the player has come back on the ice after being previously warned by the Referee, as covered in the rules. If the player comes out to play again after serving the penalty (for wearing or using dangerous equipment) and is still using or wearing the same piece of equipment, she shall be assessed a Minor penalty under this rule, plus a Gross Misconduct (for making a “travesty of the game”), as stated in Rule 4.7 (b).*

**Rule 3.8 Puck**

The puck shall be made of vulcanized rubber or other approved material. It shall be 2.54cm (1 in.) thick and 7.62cm (3 in.) in diameter and weigh not less than 156g (5 1/2 ounces) and not more than 170g (6 ounces) and shall be black in colour. For all games played under the jurisdiction of Hockey Canada, it is recommended the official HOCKEY CANADA puck be used, with the exception of Novice and below, where it shall be 2.54cm (1 in.) thick and 7.62cm (3 in.) in diameter and may weigh not less than 113.4g (4 ounces) and be clearly identified.

## SECTION 4 TYPES OF PENALTIES

See Penalty Options chart, Appendix D, on page 154 for a summary of this section.

### **Rule 4.1 Penalties**

- (a) Penalties shall be in actual playing time, and are divided into the following classes:
1. Minor Penalties
  2. Bench Minor Penalties
  3. Major Penalties
  4. Misconduct Penalties
  5. Game Ejection
  6. Game Misconduct Penalties
  7. Gross Misconduct Penalties
  8. Match Penalties
  9. Penalty Shot
- (b) Any player or team official may be assessed penalties at any time before, during, or after a game, when an offense is committed on the ice or off the ice before entering the dressing rooms. Any altercations occurring off the ice must be reported to the President on the official game report by the referee. A player who is assessed any penalty in the pre-game warm-up shall automatically have her name placed on the Official Game Report and be counted as one of the eligible players, as per Rule 2.2 (a) and (b) - Players in Uniform.

*Note 1: The maximum of 5 players per team being assessed Game Misconducts (as per Rule 9.5 (c) Note 1- Leaving the Players' or Penalty Bench) also applies to the pre-game warm-up.*

*Note 2: Any unnecessary contact between opposing players after the whistle shall result in penalties being assessed as prescribed by the rules.*

- (c) Where the rules state that the Manager or Coach shall designate a player to serve a penalty and the Manager or Coach refuses to name a player, the Referee shall name any player of the offending team to serve the penalty.
- (d) Where penalties are assessed to players of both teams at the same time, the penalized players of the Visiting Team shall take their position in the penalty bench first, in the place designated for the visiting players. Where there is no special designation they must take a position on the bench furthest from the gate.

**NEW (e) When a player is assessed both a Minor and Major penalty at the same time, the Major penalty shall be served first. The same principle will apply when a player is assessed both a Minor and Match penalty at the same time. The five-minute time penalty which accompanies the Match penalty is to be served first. See Rule 4.12 (e).**

#### *SITUATION 1 Rule 4.1 (c)*

*In any case where the Coach or Manager must designate a player to serve a penalty, the designated player must have been on the ice at the time of the infraction (this shall be interpreted as "on the ice when the play was stopped").*

**SITUATION 2 Rule 4.1 (b)**

*Penalties are assessed to players for infractions that have occurred during the pre-game warm-up.*

**QUESTION:**

*Should the players who were penalized be listed on the Official Game Report and be included in the maximum number of players a team is permitted to dress for a game, even if the Official Game Report has not yet been filled out by the coaches of one or both teams?*

**ANSWER:**

*Yes. Any player penalized during the pre-game warm-up must be listed on the Official Game Report and be included in the number of players that a team is permitted to dress.*

**SITUATION 3 Rule 4.1 (b)**

*When an infraction to the rules occurs before or after the game, and is observed by the Referee, a Linesman or the appointed Stand-by Official, the penalties as prescribed by the rules shall be assessed. When an infraction to the rules occurs after the players and team officials have entered their dressing rooms following a game and such infraction is observed by the Referee, a Linesman or the appointed Stand-by Official, a report of such infraction(s) shall be made to the President.*

**SITUATION 4**

*An incident occurs off the ice surface and is not witnessed by any On-ice Official or appointed Stand-by Official, but is reported to the Referee. What action should be taken?*

**RULING:**

*No penalties may be assessed, as the incident was not witnessed by the Referee, the Linesmen or the stand-by Official. If the incident was reported to the Referee by a League Official, a Team Official or an Off-ice Official, the Referee shall report that information to the President, immediately following the game. If the incident was reported to the Referee by any other person (i.e. fan, media), no further action should be taken.*

**Rule 4.2 Minor Penalties**

- (a) For a Minor penalty, any player, except a goaltender, shall be ruled off the ice for two minutes actual playing time, during which time no substitutes shall be permitted.
- (b) If, while a team is short-handed because of one or more Minor or Bench Minor penalties, the opposing team scores a goal, the first of such penalties shall automatically terminate.

*Note: Coincident Minor penalties to both teams do not cause either team to be short-handed.*

When a goal is scored on a Penalty Shot against a team that is short-handed by reason of a Minor or Bench Minor penalty, no player of the short-handed team shall return to the ice with the scoring of the goal.

- (c) If a goal is scored against a team that is short-handed because of one or more Minor penalties, the player serving the first Minor penalty shall return to the ice.  
In the case of a player who has received a double Minor penalty, his first Minor penalty shall be terminated.
- (d) When coincident Minor or coincident Minors of equal duration are imposed against players on each team during the same stoppage of play, immediate substitutions shall



be made for those penalties, and such penalties shall not be taken into account for the purpose of the delayed penalty. Any differences in time or total penalty time shall be served by one or more players on the ice at the time of the infraction. Unless they have been ejected from the game, such penalized players shall take their place on the penalty bench and remain there until the first stoppage of play following the expiry of their respective penalties.

Where at least one Major and/or Match penalty is assessed to each team during the same stoppage of play, the coincident Major/Match penalty rule shall take precedent over the coincident Minor penalty rule.

- (e) A Game Ejection penalty shall be assessed to any player that incurs a total of three or more stick infraction penalties during the same game. For the purpose of this rule, only high-sticking, cross-checking, slashing, butt-ending, and spearing are considered stick infractions. Players penalized under this rule shall be ordered to the dressing room for the remainder of the game.

#### SITUATION 1 Rule 4.2 (b)

*When a goal is scored and penalties are being served, the Referee would ask himself the following questions: Is the team scored on playing shorthanded? Are they serving a Minor penalty?*

#### **ACTION:**

*If the Referee answers YES to both questions, then the Minor penalty with the least amount of time remaining would be terminated. The only exception would be if the goal was scored during a Penalty Shot, in which case no player would return. Note: Coincidental penalties are not "time" penalties. They do not cause a team to be shorthanded and are never terminated by a goal.*

#### SITUATION 2 Rule 4.2 (d)

*When the coincidental penalty rule is applied and there is a differential in the total time penalties, the penalties causing the differential shall be served first in the normal manner and shall be taken into account for the purpose of applying Rule 4.2 (b), Minor Penalties and Rule 4.12, Delayed Penalties. Any time difference or differential in the total time penalties must be served by a player (or players) on the ice at the time of the infraction. Under this rule you would cancel as many penalties as possible - only the difference would be served.*

*When canceling penalties the following procedure will be used in the order listed - "MOTO":*

- i) Cancel as Many penalties as possible.*
- ii) Cancel in a way to make the team only One player short.*
- iii) Cancel in a way to avoid Taking an extra player off the ice.*
- iv) Cancel using the Order of penalty occurrence or in the order that they were reported by the Referee.*

*The following examples illustrate the above procedures. All penalties were assessed at the same stoppage.*

- i) A6 - 2      B11 - 2  
Immediate Substitution - Full Strength.*
- ii) A6 - 2      B11 - 2  
A7 - 2      B14 - 2  
Immediate Substitution - Full Strength.*

SECTION 4 - TYPES OF PENALTIES

- iii) A6 - 2      B11 - 2 + 2  
 A7 - 2  
*Immediate Substitution - Full Strength.*
- iv) A6 - 2      B11 - 2  
 A7 - 2  
*Team A will play 1 man short. A7 will serve the 2 minute time penalty. A6 penalty is cancelled due to order of occurrence.*
- v) A6 - 2      B11 - 2  
 A7 - 2      B14 - 2 + 2  
*Team B will play 1 player short for 2 minutes. B11 must serve the time penalty to avoid taking another player from the ice.*
- vi) A6 - 2      B11 - 2 + 2  
*Team B will play 1 player short for 2 minutes. Another player from the ice will serve the time penalty.*
- vii) A6 - 2      B11 - 2 + 2  
                   B14 - 2  
*Team B will resume play 1 player short for 4 minutes. B11 will serve the time penalties in order to make Team B only 1 player short.*

SITUATION 3 Rule 4.2 (b)(d)

A7 - 2	B8 - 2	4:00
A8 - 2		3:30
B Scores		3:00

A8 returns at 3:00. The coincidental penalties to A7 and B8 did not cause their team to be shorthanded.

SITUATION 4 Rule 4.2 (b)

B3 - 2		5:00
A8 - 2		4:30
A9 - 2		4:00
B Scores		3:50

A8 returns at 3:50. Team A is playing shorthanded; the first time penalty terminates.

SITUATION 5 Rule 4.2 (b)

B3 - 2		5:00
A8 - 2		4:30
A9 - 5+GM		4:00
B Scores		3:30

A8 returns. Team A is playing shorthanded and serving a Minor penalty.

SITUATION 6 Rule 4.2 (b)

A7 - 5+GM		6:30
A8 - 2		6:15
B Scores		6:10

QUESTION:

*Is the Minor penalty washed out as a result of the goal?*

ANSWER:

Yes. A8 returns.

## SITUATION 7 Rule 4.2 (b)

A8 - 2 + 2	4:00
A9 - 2	3:30
B Scores	3:00

The first penalty assessed to A8 is terminated. No one returns.

## SITUATION 8 Rule 4.2 (b)

A8 - 2 + 2	4:00
A9 - 2	4:00
B Scores	3:00

The first penalty assessed to A8 is terminated. No one returns. Order of occurrence of the penalties is the critical factor.

## SITUATION 9 Rule 4.2 (b)

A9 - 2	4:00
A8 - 2 + 2	4:00
B Scores	3:00

A9 returns. Order of occurrence of the penalties is the critical factor.

## SITUATION 10 Rule 4.2 (b)

A8 - 2 + 2	5:00
A9 - 2	4:30
B Scores	2:50

A9 returns, A8 began second penalty at 3:00.

## SITUATION 11 Rule 4.2 (b)

A6 - 5+GM	4:00
A9 - 2	3:30
B11 - 2	3:00
B Scores	2:30

A9 returns. Team A is playing shorthanded and is serving a Minor penalty.

## SITUATION 12 Rule 4.2 (d)

A8 - 2	B15 - 2	3:00
A9 - 2		3:00

All three penalties have been assessed and Team A is to play 1 player short as a result of the extra Minor to A9. Just prior to the resumption of play, B24 is assessed a Minor penalty, bringing about the following penalty situation.

A8 - 2	B15 - 2	3:00
A9 - 2	B24 - 2	3:00

## QUESTION:

Do both teams play full strength?

## ANSWER:

Yes. Immediate substitution for all players.

## SITUATION 13 Rule 4.2 (d)

A8 - 5 +GM+ 2	B9 - 2	3:00
---------------	--------	------

The coincidental Minor penalty rule applies. A player from the ice will serve the 5 minute time penalty to A8.

## SITUATION 14 Rule 4.2 (d)

A8 - 2	B3 - 2	4:00
A9 - 5+GM		3:30
B Scores		3:00

No player returns. The only time penalty being served by Team A is the Major to A9.

## SITUATION 15 Rule 4.2 (d)

A6 - 2	B14 - 2 + 2	5:00
	B16 - 5+GM	5:00
A Scores		4:30

The coincidental penalty rule required a player from the ice to serve B14's 2 minute time penalty. This player would return with the scoring of the goal at 4:30. B14 would now start serving his coincidental penalty and would return at the first stoppage of play after 2:30.

## SITUATION 16 Rule 4.2 (d)

A6 - 2	B14 - 2	5:00
	B16 - 5+GM + 2	5:00
A Scores		4:15

No player returns. A player from the ice serves the 5 + 2 penalty to B16.

## SITUATION 17 Rule 4.2 (d)

A6 - 2	B14 - 2	10:00
	B16 - 5+GM+2	10:00
A Scores		4:45

A player from the ice serving the Minor penalty to B16 returns. A6 and B14 return at 4:45 (or the first stoppage of play on or after 8:00).

## SITUATION 18 Rule 4.2 (d)

A6 - 2	B7 - 2	1:30
--------	--------	------

In this situation, late in a period where players would not be eligible to return to the ice prior to the conclusion of the period, it is acceptable to send the players to their respective dressing rooms to avoid confrontation at period end. The Referee would be expected to take charge of this situation. (This procedure is only recommended in situations where there is adequate security and control for the players.)

## SITUATION 19

A7 - 2 + 10 + GM	B8 - 2	5:00
------------------	--------	------

Immediate substitution. Team "A" is not required to place a substitute in the penalty box for A7.

## SITUATION 20

At the 6:00 mark, A3 is assessed 2+2. At the 5:00 mark, B7 scores, but before play resumes B8 is assessed a Minor penalty.

## QUESTION:

Are the Minor penalties to A3 and B8 considered coincidental or do they play 4 on 4 with two minutes showing on each team's penalty time clock?

## ANSWER:

The penalties must be assessed at the same stoppage of play in order to be considered coincidental. Therefore, the teams would play 4 on 4 for two minutes.

**SITUATION 21 Rule 4.2 (e)**

*A player must have committed three stick infractions or more and not three penalties or more.*

**EXAMPLE A:**

*A player receives a Minor penalty for high sticking, a Minor penalty for slashing and a Minor penalty for butt-end hooking.*

**RULING:**

*The Game Ejection Rule does not apply.*

**EXAMPLE B:**

*A player receives a Minor penalty for high sticking and a double Minor for spearing.*

**RULING:**

*The Game Ejection penalty does not apply. The player has received three Minor penalties, but has only committed two stick infractions.*

**EXAMPLE C:**

*A player has received two stick infraction penalties. There is an obvious third stick infraction committed by this player and the Referee has the penalty on delay. The non-offending team scores a goal to nullify this penalty.*

**RULING:**

*The Game Ejection Rule does not apply.*

**EXAMPLE D:**

*A player has received two stick infraction penalties. There is an obvious third stick infraction committed by this player and the Referee has the penalty on delay. The offending team is already shorthanded and is serving a Minor penalty. The non-offending team scores during the delayed calling of the stick infraction penalty.*

**RULING:**

*The scoring of the goal nullifies the penalty being served and the stick infraction penalty is assessed along with the Game Ejection.*

**EXAMPLE E:**

*A player has received two stick infraction penalties. There is an obvious third stick infraction committed by this player that calls for a double Minor penalty and the Referee has the penalty on delay. Subsequently, the non-offending team scores.*

**RULING:**

*The first of the double Minor penalties is nullified by the goal. The second penalty is assessed and the Game Ejection penalty applies.*

**Rule 4.3 Bench Minor Penalties**

- (a) A Bench Minor penalty requires the team against which the penalty is assessed to play a man short for a period of two minutes of actual playing time.
- (b) Whenever a Bench Minor penalty is to be assessed according to the rules, if the player guilty of the actual infraction (including players in the penalty box) is identified by the Referee, that player shall serve the penalty. However, if the player is not identified, then the Manager or Coach of the penalized team, through the playing Captain, shall designate any player of her team on the ice at the time of the infraction to serve the penalty.

**SITUATION 1**

*Where a team is assessed a Bench Minor Penalty, that penalty must be served by a player on the ice. Following this and during the same stoppage of play, the team is assessed another Bench Minor penalty. A second player who was on the ice must serve this second Bench Minor penalty.*

**Rule 4.4 Major Penalties**

- (a) Any player, goaltender or Team Official incurring a Major penalty shall be assessed a Game Misconduct penalty, shall be ordered to the dressing room for the remainder of the game, and shall be reported to the President for further action. The Manager or Coach of the penalized team, through the playing Captain, shall designate any player of her team on the ice at the time of the infraction to serve the penalty.
- (b) When coincident Major and/or Match penalties or coincident penalties of equal duration including a Major or a Match are imposed against players on each team during the same stoppage of play, immediate substitutions shall be made for those penalties, and such penalties shall not be taken into account for the purpose of the delayed penalty.

*When the coincident Major/Match penalty rule is applied and there is a differential in the total time penalties, those penalties causing the differential shall be served first in the normal manner and shall be taken into account for the purpose of applying Rule 4.2 (b) - Minor penalties and Rule 4.12 - Delayed penalties. Any time difference or differential in the total time penalties must be served by a player (or players) on the ice at the time of the infraction.*

**SITUATION 1****Rule 4.4 (b)**

*When canceling coincident Major/Match penalties the following procedure will be used in the order listed - "MOTO":*

- i) Cancel as Many penalties as possible.*
- ii) Cancel in a way to make the team only One player short.*
- iii) Cancel in a way to avoid Taking an extra player off the ice.*
- iv) Cancel using the order of penalty Occurrence or in the order that they were reported by the Referee.*

*In order to apply this rule there must be at least one Major/Match penalty to each team. The following examples illustrate the above procedure. All penalties were assessed at the same stoppage.*

- i) A6 - MATCH ( 5 )      B12 - 5+GM  
Immediate Substitution - Full Strength.*
- ii) A6 - 5+GM+5+GM      B12 - 5+GM  
  B11 - 5+GM  
Immediate Substitution - Full Strength.*
- iii) A6 - 5+GM              B12 - 5+GM  
      A7 - 5+GM  
Team A to resume play 1 player short. A7 time penalty to be served by player from on the ice. A6 penalty is cancelled due to order of occurrence.*

SECTION 4 - TYPES OF PENALTIES

- iv) A6 - 5+GM+5+GM B12 - 5+GM  
*Team A will play 1 player short for 5 minutes. Team A must take a player from the ice to serve the time penalty.*
- v) A6 - 5+GM+2 B7 - 5+GM + 2  
*Immediate Substitution - Full Strength.*
- vi) A6 - 5+GM+2 B7 - 2  
 B8 - 5+GM  
*Immediate Substitution - Full Strength.*
- vii) A6 - 5+GM+2 B8 - 2 + 2  
 A7 - 5+GM+2 B9 - 5+GM+5+GM  
*Immediate Substitution - Full Strength.*

SITUATION 2 Rule 4.4 (b)

A3 - 2 B7 - 2  
 A4 - 2 B8 - 5+GM  
 A6 - 5+GM  
*Team A will resume play 1 player short for 2 minutes. A4 will serve the time penalty because of order of occurrence.*

SITUATION 3 Rule 4.4 (b)

A3 - 5+GM+ 2 B7 - 2  
 A4 - 5+GM+2+2 B8 - 5+GM+ 2  
 A6 - 5+GM B9 - 5+GM+5+GM+ 2  
*Immediate Substitution - Full Strength.*

SITUATION 4 Rule 4.4 (b)

*A player involved in the coincidental penalty rule may go to the dressing room and not be replaced by a substitute on the penalty bench. This is the same procedure followed as in the case of a player serving a Misconduct, Game Misconduct, Gross Misconduct or Game Ejection penalty. The only case where a substitute would be required on the penalty bench is where a player must serve a time penalty with his team playing shorthanded.*

SITUATION 5 Rule 4.4 (b)

*A player involved in the coincidental penalty rule must serve the full amount of time assessed to him, except if a goal scored against his team washes out a portion of a Minor penalty.*

A9 - 5+GM+ 2 B14 - 5+GM 8:40  
 B Scores 8:25  
*The coincidental penalty rule is applied and immediate substitution is permitted for B14. Team A is required to send a player from the ice to the penalty bench to serve the time penalty assessed to A9. The time penalty starts at 8:40. With the goal by Team B at 8:25, the time penalty being served is washed out.*

SITUATION 6 Rule 4.4 (b)

A6 - 5+GM + 2 B11 - 5+GM  
 A7 - 5+GM  
*Team A will play 1 player short for 7 minutes. A7 will cancel with B11 to place Team A only 1 player short.*

## SITUATION 7 Rule 4.4 (b)

A6 - 2+2	B11 - 5+GM+2
A7 - 5+GM+ 2	B12 - 5+GM+5+GM
A8 - 5+GM	

Team A and B will each resume play 1 player short. A6 will serve the 4 minute time penalty. Team B will need a player from the ice to serve the 5 minute time penalty to B12.

## SITUATION 8 Rule 4.4 (b)

A6 - 5+GM+2	B11 - 5+GM+5+GM+2+2
A7 - 5+GM	B12 - 5+GM+5+GM
A8 - 5+GM	

Team B will start 1 player short. Team B will need a player from the ice to serve the 7 minute time penalty to B11. The Major is to be served first.

## SITUATION 9 Rule 4.4 (b)

A6 - 2	B11 - 5+GM+5+GM
A7 - 5+GM+2	B12 - 5+GM
A8 - 5+GM	

Team A will start 2 players short. A6 will serve the 2 minute time penalty. Another player from the ice will serve the 2 minute time penalty to A7. Team B will start one player short with a player from the ice serving the 5 minute time penalty to B12.

## SITUATION 10 Rule 4.4 (b)

A3 - 5+GM+ 2	B7 - 2
A6 - 5+GM+2+2	B8 - 2
A9 - 5+GM	B11 - 5+GM+2
	B12 - 5+GM+5+GM+2

Team B will resume play 1 player short. The Minors to B11 and B12 are cancelled to avoid taking another player from the ice. B8 serves the time penalty. B7 penalty is cancelled because of order of occurrence.

## SITUATION 11 Rule 4.4 (b)

A3 - 5+GM+2	B7 - 5+GM+2
A4 - 5+GM+2+2	B8 - 5+GM+5+GM

Both teams will resume play 1 player short. Team A will need 1 player from the ice to serve the 4 minute time penalty to A4. Team B will need 1 player from the ice to serve the 5 minute time penalty to B8.

## SITUATION 12 Rule 4.4 (b)

A6 receives a 5 minute Major and automatic Game Misconduct for High-sticking. Subsequently is assessed a 5 minute Major for fighting with B12.

**RULING:**

A6 - 5 and automatic Game Misconduct for High-sticking + 5 and automatic Game Misconduct for Fighting. B12 - 5 and automatic Game Misconduct for Fighting. Plus any other penalties incurred.

Note: A6 is not assessed a 3rd Game Misconduct for incurring two Major penalties in the same game.

## SITUATION 13

The Referee has assessed a player a Minor penalty and it is announced as a Minor. He then realizes that the penalized player, having injured an opponent, should have received a Major and Game Misconduct.



**QUESTION:**

*Should the Referee change the penalty from a Minor to a Major and Game Misconduct?*

**ANSWER:**

Yes.

**Rule 4.5 Misconduct Penalties**

- (a) A player, except a goaltender, incurring a Misconduct penalty, shall be ruled off the ice for a period of ten minutes actual playing time. A substitute for the penalized player shall be permitted immediately. A player serving a Misconduct penalty shall remain on the penalty bench until the first stoppage of play following the expiry of her penalty. When a player is assessed a Minor and a Misconduct penalty or a Major and a Misconduct penalty at the same time, the penalized team shall immediately place a substitute player on the bench to serve the Minor or Major penalty. The Misconduct penalty will commence on the termination of the Minor or Major penalty.
- (b) The Referee in charge shall report to the President any player who is assessed a Misconduct penalty within ten minutes of the conclusion of the game.
- (c) Any player who is assessed a second Misconduct penalty in the same game shall automatically be assessed a Game Misconduct penalty.

**SITUATION 1**

*A player of Team "A" is serving a Minor penalty in the penalty box. While she is serving this penalty, she is assessed a Misconduct. How does the Referee handle this situation?*

**RULING:**

*Team "A" shall place another player in the penalty box to serve the remainder of the original Minor. The original player of Team "A" would now remain in the penalty box for 10 minutes in addition to the two minutes, unless a goal was scored that would shorten the time of that Minor penalty.*

**SITUATION 2****QUESTION:**

*Where a team is to be assessed a Misconduct (delayed) but is scored upon before play is stopped,*

- (a) *Is the Misconduct still assessed ?*
- (b) *Does she put her arm in the air to signal the delayed penalty?*

**ANSWER:**

Yes, for both (a) & (b).

**SITUATION 3**

*When a player refuses to surrender her stick or intentionally breaks it, when asked for a measurement, a Minor penalty and a Misconduct shall be assessed.*

**Rule 4.6 Game Ejection/Game Misconduct Penalties**

- (a) A player incurring a Game Ejection penalty in accordance with Rule 4.2 (e) - Minor penalties, shall be ordered to the dressing room for the remainder of the game.
- (b) A player or team official incurring a Game Misconduct penalty shall be ordered to the dressing room for the remainder of the game and shall be reported to the President for

further action. A substitute for the penalized player shall be permitted immediately. A total of ten minutes shall be charged in the records against the penalized player for a Game Misconduct.

- NEW** (c) Any player or team official who is assessed a Game Misconduct penalty in the last ten minutes of regular time, **at** any time in overtime, or **after** the conclusion of the game and prior to the player or team official entering his dressing room, shall automatically be suspended for a minimum of the next regular league/play-off game or seven days.

*SITUATION 1 Rule 4.6 (a)*

*It should be noted that a Game Ejection is not equal to a Game Misconduct. A Minor Hockey player receiving a Game Ejection in the last ten minutes of regular play is not automatically suspended for the next regular league or play-off game.*

**Rule 4.7 Gross Misconduct Penalties**

- (a) Any player or team official incurring a Gross Misconduct penalty shall be ordered to the dressing room for the remainder of the game and shall be reported to the President for further action. A substitute for the penalized player shall be permitted immediately. A total of ten minutes shall be charged in the records against the penalized player for a Gross Misconduct.

**NEW** (b) **A Gross Misconduct penalty shall be assessed any player or team official who conducts herself in such a manner as to make a travesty of the game.**

- NEW** (c) Any player or team official who is assessed a Gross Misconduct penalty in the last ten minutes of regular time, **at** any time in overtime, or **after** the conclusion of the game and prior to the player or team official entering his dressing room, shall automatically be suspended for a minimum of the next regular league/play-off game or seven days.

*SITUATION 1 Rule 4.7 (b)*

*Whenever a Referee is certain that a player or team official has been drinking alcohol prior to the game or is acting under the influence of alcohol, such player or team official should be encouraged to voluntarily withdraw from the game. However, should a further incident occur requiring penalties which entail a written report, the possible use of alcohol should be noted in the game report.*

*SITUATION 2 Rule 4.7 (b)*

*Where a player on the ice or on the bench becomes involved in a fight with a team official or a spectator, the player shall be assessed a Gross Misconduct. See Rule 6.1, Situations 3, 4, and 5; and Rule 6.7, Situation 6.*

*SITUATION 3 Rule 4.7 (b)*

*When a player or team official sprays water out of a drinking bottle on or at an On-ice or Off-ice Official, the Referee is directed to assess a Bench Minor penalty. If the player or team official can be identified, a Gross Misconduct shall also be assessed.*

**Rule 4.8 Match Penalties**

- (a) Any player or team official incurring a Match penalty shall be ordered to the dressing room immediately, for the balance of the game, and will not be permitted to take part in any further games until his case has been dealt with by the President.

- (b) In every instance where a Match penalty has been assessed, the offending player's team shall be required to send a player to the penalty box for five minutes. The player who serves the five minutes must have been on the ice at the time of the infraction. Where an offending player has been assessed penalties in addition to the Match penalty, those penalties will be served by the same player who serves the five minute penalty. This section would not apply in the case of the coincident Major or Match penalty rule.

*Note: Referees are required to report all Match penalties and the surrounding circumstances to the President immediately following the game involved. THIS IS IMPORTANT.*

#### SITUATION 1

*A player incurring a Match penalty does not automatically receive a Game Misconduct. He is simply removed from the game and, if a time penalty results, a substitute from the ice serves the 5 minute time penalty.*

### Rule 4.9 Penalty Shot

- (a) Any infraction of the rules which calls for a Penalty Shot shall result in the following: The Referee shall cause to be announced over the public address system the name of the player designated by her or selected by the team entitled to take the shot (as appropriate), and shall then place the puck on the centre face-off spot and the player taking the shot will, on instruction of the Referee, play the puck from there and shall attempt to score on the goaltender. The puck must be kept in motion towards the opponents' goal line and once it is shot the play is to be considered complete. No goal can be scored on a rebound of any kind and any time the puck crosses the goal line, the shot shall be considered complete.
- (b) The goaltender must remain in her goal crease until the designated player touches the puck at centre ice, and in the event of a violation of this rule, the player designated or selected to take the shot shall be entitled to take the shot over again.

The goaltender may attempt to stop the shot in any manner except by throwing her stick or any other object, or deliberately dislodging the goal, in which case a Goal shall be awarded.

*Note 1: No player other than a goaltender is permitted to tend goal during a Penalty Shot.*

- (c) In cases where a Penalty Shot has been awarded under Rule 3.6 (c) - Protective Equipment (deliberate removal of helmet or facial protector during a breakaway), Rule 10.1 (d) - for Delay of Game (Goaltender deliberately dislodging the goal during a breakaway), Rule 9.8 (a) - Throwing Stick (at puck or puck carrier), Rule 7.4 (d) - Tripping (fouling from behind), and Rule 9.5 (e) - Leaving the Players or Penalty Bench (ineligible player), the Referee shall designate the player who has been fouled as the player who shall take the Penalty Shot. If by reason of injury, the player designated by the Referee to take the Penalty Shot is unable to do so or again if the player fouled is not identifiable, the Penalty Shot shall then be taken by a player who was on the ice at the time of the infraction, and is selected by the Captain of the non-offending team and her selection reported to the Referee. In cases where a Penalty Shot has been awarded under Rule 10.1 (e) - Delay of Game, Rule 10.3 (c) - Falling on the Puck (in the goal crease) and Rule 9.1 (c) - Handling the Puck (in the goal crease), the Penalty Shot may be taken by a player selected by the Captain of the non-offending team and

her selection reported to the Referee. This player must be on the ice at the time of the infraction.

- (d) Should the player in respect to whom a Penalty Shot has been awarded, herself commit a foul in connection with the same play or circumstances after the Penalty Shot has been awarded, she shall first be permitted to take the Shot before being sent to the penalty bench to serve the penalty, provided the penalty assessed was not a Game Ejection, Game Misconduct, Gross Misconduct or Match penalty. If at the time a Penalty Shot is awarded, the goaltender of the penalized team has been removed from the ice to substitute another player, the goaltender shall be allowed to return to the ice before the Penalty Shot is taken.
- (e) While the Penalty Shot is being taken, players of both sides shall withdraw to the sides of the rink and beyond the centre red line.
- (f) If, while the Penalty Shot is being taken, any player of the opposing team shall have by some action interfered with or distracted the player taking the Penalty Shot, and because of such action the shot should have failed, a second attempt shall be permitted and the Referee shall assess a Misconduct penalty to the player.

If the interference is from a team official, a Game Misconduct penalty shall be assessed.

- (g) If a goal is scored from the Penalty Shot, the puck shall be faced-off at centre ice in the usual way. If the goal is not scored, the puck shall be faced-off at either end zone face-off spot in which the Penalty Shot was attempted.
- (h) Should a goal be scored from a Penalty Shot, a further penalty to the offending player shall not be applied unless the offense for which the Penalty Shot was awarded was such as to incur a Major or Match penalty, in which case the penalty prescribed for the particular offense shall be assessed. If the offense for which the Penalty Shot was awarded was such as would normally incur a Minor penalty, then regardless of whether the Penalty Shot results in a goal or not, no further Minor penalty shall be served.
- (i) A measurement of the stick of the player designated to take the Penalty Shot may be requested before the shot is taken, as if it were a normal play. Should the stick prove illegal, the offending team shall be denied the Penalty Shot and no further penalty shall be imposed. Should the measurement prove the stick to be legal, the Penalty Shot shall be taken in the normal manner and the penalty for an “unsustained request for a measurement” shall be assessed whether the Penalty Shot is successful or not.
- (j) If the foul upon which the Penalty Shot is based occurs during actual playing time, the Penalty Shot shall be awarded and taken immediately in the usual manner notwithstanding any delay occasioned by a slow whistle by the Referee to permit the play to be completed, which delay results in the expiry of the regular playing time in any period. The time required for the taking of a Penalty Shot shall not be included in the regular playing time or any overtime.
- (k) Note: Also refer to:
  - Rule 3.6 (c),
  - Rule 7.3 (f),
  - Rule 7.4 (d),
  - Rule 9.1 (c),
  - Rule 9.5 (e),
  - Rule 9.8 (a),

Rule 10.1 (d),  
 Rule 10.1 (e),  
 Rule 10.3 (c),  
 Rule 10.14 (a),  
 Rule 10.14 (e).

## SITUATION 1

*A Penalty Shot may be awarded due to the following illegal acts:*

1. *Rule 2.5 (f) - Change of Players When, in the last two minutes of regular playing time, or anytime in overtime a team is penalized for DELIBERATE illegal substitution (deliberately having too many men on the ice). Also refer to Rule 10.1 (e).*
2. *Rule 3.6 (c) - Protective Equipment*
  - a. *When a goaltender or any other defending player deliberately removes her helmet or facial protector during the course of a breakaway in the neutral or attacking zone. Rule 3.6, Situation 6.*
  - b. *When a defending player deliberately participates in the play without a helmet or facial protector during the course of a breakaway in the neutral or attacking zone. Rule 3.6, Situation 5.*
  - c. *When a goaltender in her defending zone, deliberately removes her helmet or facial protector during the last two minutes of regular playing time, or any time in overtime. Rule 3.6, Situation 4. Also refer to Rule 10.1 (e).*
3. *Rule 10.1 (c) - Delay of Game When a goaltender or any other defending player, in her defending zone, deliberately dislodges the goal from its position during the last two minutes of regular playing time, or any time in overtime. Also refer to Rule 10.1 (e).*
4. *Rule 10.1 (d) - Delay of Game When a goaltender deliberately dislodges the goal from its position during the course of a breakaway in the neutral or attacking zone.*
5. *Rule 10.1 (e) - Delay of Game When, in the last two minutes of regular playing time, or any time in overtime, a team is penalized for:*
  - a. *Deliberate illegal substitution Rule 2.5 (f), or*
  - b. *Deliberately removing a helmet or facial protector Rule 3.6 (c), or*
  - c. *Deliberately knocks the goal from its position Rule 10.1 (c), or*
  - d. *Refusing to start play Rule 10.14 (a).*
6. *Rule 10.3 (c) - Falling on the Puck When a defending player (except the goaltender) deliberately falls on the puck, holds or gathers the puck into her body in any manner or picks up the puck with her hand, while the puck is within her goal crease. Rule 10.3, Situation 1.*
7. *Rule 9.1 (c) - Handling the Puck When a defending player (except the goaltender) picks up the puck from the ice with her hand while the puck is in her team's goal crease.*
8. *Rule 7.3 (f) - A Minor penalty shall be assessed a goaltender who deliberately piles up snow or other obstacles at or near his net which, in the Referee's opinion, would tend to prevent a goal from being scored. A penalty shot shall be assessed if such obstacle prevents a goal while the offending team's goaltender is legally on the ice.*
9. *Rule 9.5 (e) - Leaving the Players' or Penalty Bench When a player on a breakaway in the neutral or attacking zone is interfered with by a player of the opposing team who shall*

have illegally entered the game or by a player or team official on the players' or penalty bench. Rule 9.5, Situations 1, 2, and 3.

10. Rule 10.14 (a) - Refusing to Start Play When, in the last two minutes of regular playing time, or any time in overtime, the coach is assessed a Major penalty plus a Game Misconduct for refusing to start play, a Penalty Shot shall also be awarded against that team. Also refer to Rule 10.1 (e).
11. Rule 9.8 (a) - Throwing Stick When any player of the defending team, including the goaltender, deliberately throws her stick or any part thereof or any other object at the puck or puck carrier in the defending zone.
12. Rule 7.4 (d) - Tripping When a player in control of the puck on a breakaway in the neutral or attacking zone is tripped or otherwise fouled from behind and thus prevented from having a clear shot on goal, having no opponent to pass other than the goaltender.
13. Rule 10.14 (e) - A player or team official who refuses to leave the bench or playing area after he has been assessed a Game Misconduct penalty, Gross Misconduct or Match penalty, TWO MINUTES AFTER BEING ORDERED TO DO SO BY THE REFEREE, the game or series shall be suspended. The team officials and/or players of the teams which are responsible for any of these actions may be suspended for one year or more from the date of the infraction. The Referee shall report full details of the incident to the president. IF THE PLAYER OR TEAM OFFICIAL AFTER BEING ORDERED TO LEAVE, DOES LEAVE THE BENCH OR THE ICE, then a Major penalty and a Game Misconduct shall be assessed to the Coach for Delay of Game. If this infraction occurs in the last two minutes of regular playing time, or anytime in overtime, a Penalty Shot (in addition to the Major Penalty and a Game Misconduct) shall be awarded against the offending team's, as stated in Rule 10.1 (e) - Delay of Game.

## SITUATION 2

Where a Penalty Shot has been awarded during a game, this shall be recorded on the Official Game Report, along with the time it was awarded, the player designated to take the shot and whether or not the goal was scored on the play. In order to assess a Penalty Shot as a result of a foul against the puck carrier, the following conditions must be met:

1. The attacking player must have control of the puck.
2. The determining factor is the position of the puck when the infraction is committed. The puck must be in the neutral or attacking zone when the infraction is committed.
3. The attacking player must have no defending player to pass other than the goaltender.
4. The attacking player must be fouled from behind.
5. The attacking player must have been denied a reasonable scoring opportunity. Note: In point No. 5 of this situation, where reference is made to the "attacking player", it means the player in possession and control of the puck.

### EXAMPLE:

If two players are on a breakaway in the neutral or attacking zone and the player in control of the puck is fouled from behind, causing him to lose control of the puck and the other attacking player picks up the puck and gets a clear shot on goal and does not score, a Penalty Shot must still be awarded to the player originally fouled.

## SITUATION 3

General Notes on Penalty Shots:

1. A goaltender is the only player allowed to defend the goal during a Penalty Shot (except as explained in Rule 2.6, Situation 3 and in Rule 4.9, Situation 4).

2. A substitute goaltender is not allowed a warm-up prior to a Penalty Shot - Rule 2.2 (f).
3. A player to whom a Penalty Shot has been awarded who herself commits a foul in connection with the same play or circumstances after the Penalty Shot has been awarded, will be allowed to take the Penalty Shot, provided the penalty she is to be assessed is not a Game Ejection, Game Misconduct, Gross Misconduct or Match penalty - Rule 4.9 (d).
4. A player of the opposing team who distracts a player taking a Penalty Shot is to be assessed a Misconduct (whether a goal is scored or not) and if the Penalty Shot fails, another attempt is awarded - Rule 4.9 (f). If it were a team official involved, the penalty assessed would be a Game Misconduct rather than the Misconduct.
5. If the foul on which the Penalty Shot is based occurs during the actual playing time the Shot will be awarded in all cases, even though regular playing time in any period may have expired - Rule 4.9 (j).

## SITUATION 4

## QUESTION:

A team is playing with 6 players and does not have a goaltender dressed in goaltender's equipment. A Penalty Shot is awarded against that team. Who defends the goal against the Penalty Shot?

## ANSWER:

Since the team has no goaltender, they must designate a player. This player shall be entitled to the privileges of a goaltender and must follow the same rules and procedures as a regular goaltender during the Penalty Shot.

She is not required to wear the entire goaltender's equipment but must wear the mandatory equipment as covered by the rules; helmet, facial protection and goaltenders stick. After the Penalty Shot has been taken, the player may be classified again as a regular player. This only applies when a team has no goaltender and only in the case of a Penalty Shot.

## SITUATION 5 Rule 4.9 (d)

A player who has been awarded a Penalty Shot is assessed a Match penalty for a foul in connection with the same play or circumstances after the Penalty Shot has been awarded. How do you handle this situation?

## ANSWER:

The player shall NOT be permitted to take the Penalty Shot and the Captain shall designate another player (on the ice at the time of the infraction) to take the Penalty Shot.

## SITUATION 6 Rule 4.9 (a) states "...The puck must be kept in motion towards the goal line..."

## QUESTION:

On a Penalty Shot, while going in on the goal, the player loses control of the puck or over skates it, forcing her to go back and retrieve it and then make her play on the goal. Is this legal?

## ANSWER:

As long as the puck continues in motion towards the opponents' goal line, the player may go back and pick up the puck.

## QUESTION:

On a Penalty Shot, the player advances to the puck and inadvertently misses the puck. The puck has not been put into motion. Can the player circle back and start again?

## ANSWER:

Yes, but once the puck is put into motion, it must be kept in motion towards the goal.

**NEW QUESTION:**

Can a player use the 'spin-o-rama' move on a penalty shot or in a shoot-out?

**ANSWER:**

Yes, the spin-o-rama type move where the player completes a 360o turn as he approaches the goal, shall be permitted as this involves continuous motion.

**QUESTION:**

Can a player use a 'lacrosse style' of move?

**ANSWER:**

Yes providing the puck on the stick blade not be raised or carried above the height of the shoulders, and if it is, the shot shall be stopped immediately by the Referee. When the puck is released from the stick, the puck cannot be above the height of the cross bar.

**SITUATION 7 Rule 4.9 (a)**

*On a Penalty Shot, as the player approaches the goal, the goaltender poke checks the puck. The puck bounces past the goaltender toward the net. The player regains the puck and directs it into the goal. Is the goal allowed?*

**RULING:**

*No goal. Once the goaltender has made contact with the puck causing the player to lose control, the player can no longer touch the puck. However, if the puck continues on with it's own momentum into the goal, the goal shall be allowed.*

**SITUATION 8 Rule 4.9 (a)** states "...No goal can be scored on a rebound of any kind and any time the puck crosses the goal line, the shot shall be considered complete".

*The word "rebound" seems to cause considerable confusion with respect to a goal being scored on a Penalty Shot. The following is a brief summary and intent of the words "No goal can be scored on a rebound of any kind". The player taking the Penalty Shot shoots the puck and:*

1. *The puck hits the goal post then goes into the goal - Goal is allowed.*
2. *The puck hits the goaltender then goes into the goal - Goal is allowed.*
3. *The puck hits the goal post, then hits the goaltender and goes into the goal - Goal is allowed.*
4. *The puck hits the goaltender, then hits the goal post and goes into the goal - Goal is allowed.*
5. *The puck, after being shot, contacts the boards or attacking player and then goes into the goal. No goal.*

**SITUATION 9 Rule 4.9 (a)****QUESTION:**

*On a Penalty Shot, the puck hits the glass behind the goaltender, bounces back, hits the goaltender on the back and goes into the goal. Is the goal allowed ?*

**ANSWER:**

*No. As soon as the puck crosses the goal line the Penalty Shot shall be considered complete.*

**SITUATION 10 Rule 4.9 (i)**

*A player has been awarded a Penalty Shot. The opposing team requests a measurement of that player's stick prior to the Penalty Shot being conducted.*



**QUESTION:**

*What happens if the player refuses to surrender her stick or intentionally breaks the stick, when asked to surrender it for measurement?*

**ANSWER:**

*The player's team shall be denied the Penalty Shot and the player guilty of this gesture shall be assessed a Misconduct. Please note that the Minor penalty for an illegal stick would not be assessed, as that penalty is offset by the cancellation of the Penalty Shot.*

**SITUATION 11 Rule 4.9 (i)**

*After a Penalty Shot has been executed, and regardless of whether a goal is scored, either team may request a stick measurement of any player on the ice prior to the resumption of play. The one measurement per stoppage of play would apply. However, the results of the stick measurement will in no way effect anything that has occurred prior to the measurement.*

**SITUATION 12 Rule 4.9 (b)**

*If a goaltender leaves her goal crease too soon on a Penalty Shot, the Referee shall allow the play to be completed and if a goal is not scored, the player shall be allowed to repeat the Penalty Shot. If it is apparent that the goaltender is trying to delay the game, warn her that a second violation will result in a Misconduct. Any subsequent delay would entail a Game Misconduct.*

**SITUATION 13**

*Team "A" No. 10 is serving a Minor penalty. Another player of Team "A", No. 8, is to be assessed a delayed penalty for slashing. Before play is stopped, Team "B" is awarded a Penalty Shot, due to an additional foul by Team "A". Team "B" scores on the Penalty Shot.*

**RULING:**

*The penalty to Team "A" No. 10 remains in effect, and Team "A" No. 8 must serve the time penalty for slashing. Note: Goals scored on a Penalty Shot do not affect penalties being served or on delay. See Rule 4.2 (b).*

**SITUATION 14 Rule 4.9 (h)**

*A player on a breakaway in the neutral or attacking zone is fouled in such a way that the infraction would incur a Major penalty plus an automatic Game Misconduct, (i.e. slashing resulting in an injury) as well as a Penalty Shot, if a goal is not scored before the stoppage of play. However, the player scored on the Penalty Shot.*

**RULING:**

*The Major penalty plus an automatic Game Misconduct is assessed, regardless of the fact that a Penalty Shot is awarded on the play and regardless of the fact that a goal may be scored on the play or on the Penalty Shot.*

**SITUATION 15****QUESTION:**

*A player on a breakaway in the neutral or attacking zone is fouled from behind and the Referee signals a Penalty Shot. Before the play is completed a second infraction is signaled against the same team, whether it be to the same player or a different player. The Penalty Shot washes out the first infraction. Is the penalty for the second infraction still assessed?*

**ANSWER:**

*Yes.*

## SITUATION 16

*A player on a breakaway in the neutral or attacking zone is tripped or fouled from behind by an opponent, such that a Penalty Shot would be awarded. Before play is stopped, a player or the goal tender of the offending team throws a stick or any other object at the puck in the defending zone.*

**RULING:**

*Award two Penalty Shots. If a goal is scored on the first Shot, cancel the second Shot. However, the appropriate penalty, as prescribed by the rules, shall be assessed for the second infraction (i.e., hooking, slashing, etc.).*

*Note: A maximum of 2 Penalty Shots may be awarded to either one or two players (depending on the situation) during the same play sequence. If any further infraction warranting the awarding of third Penalty Shot was committed by the same team during the same play sequence, that Penalty Shot would be replaced by the appropriate penalty, as prescribed by the rules.*

## SITUATION 17 Rule 3.1 (c)

*Team "A" has been awarded a Penalty Shot due to a foul committed by a player of Team "B".*

**QUESTION:**

*Can the goaltender of Team "B" go to his players' bench to receive instructions, prior to the commencement of the Penalty Shot, without being changed?*

**ANSWER:**

*No, if the goaltender goes to his players' bench he must be replaced. Any instructions must be relayed to him by a player of his team while he remains in the goal area prior to the Penalty Shot. If the team does not have a substitute goaltender and the regular goaltender goes to the bench prior to the Penalty Shot without the permission of the Referee, a Minor penalty for Delay of Game shall be assessed.*

**QUESTION:**

*Can the goaltender of Team "A" go to his players' bench while the Penalty Shot is in progress, without being replaced when play resumes?*

**ANSWER:**

*Yes, under Rule 4.9 (e), "...players of both sides shall withdraw to the sides of the rink..."*

**QUESTION:**

*What would happen if in the process of a Penalty Shot the goaltender accidentally dislodges the net off the moorings?*

**ANSWER:**

*Award another penalty shot as the actions of the goaltender were not intentional. However, if the puck should enter the net before the net is dislodged, the goal shall be allowed and no repeat shot will be taken.*

**Rule 4.10 Awarded Goals**

- (a) A "Goal" will be awarded to the attacking team when the opposing team has taken their goaltender off the ice and an attacking player has possession and control of the puck on a breakaway in the neutral or attacking zone without a defending player between himself and the opposing goal and:
- (1) he is interfered with by an opposing player who has illegally entered the game or,
  - (2) a stick or any other object is thrown by a player on the defending team or,

- (3) the puck carrier is fouled from behind and prevented from having a clear shot on the open goal or,
- (4) any member of the defending team including the team officials, whether on the players' bench or penalty bench, interferes by means of his body, stick or any other object with the puck or the puck carrier.

**NEW (b) A Goal will be awarded to the attacking team when the opposing team has taken their goaltender off the ice and when a shot has been taken (control no longer applies) and a defending player picks up the puck with his hand from the goal crease or intentionally falls on or covers the puck in the crease.**

- (c) A Goal will be awarded when the goaltender is removed from the ice and he, or any teammate, has deliberately piled snow or any other obstacle at or near his net, or has deliberately dislodged the net from its moorings, when any such action has prevented a goal from being scored.

#### SITUATION 1

**QUESTION:**

*May a goal be awarded when the goaltender is on the ice?*

**ANSWER:**

Yes. See Rule 4.9 (b), Rule 4.10, Situation 3, and Rule 3.6, Situation 7.

#### SITUATION 2 Rule 4.10 (a) (1), (2), (3), (4)

*The determining factor for this rule is that the PUCK must be in the neutral or attacking zone not the player in possession and control of the puck, or his skates. Any such infraction taking place after the puck is in the neutral or attacking zone shall result in an Awarded Goal. Any such action taking place before the puck is in the neutral or attacking zone shall be dealt with as follows:*

- a) *For a player illegally entering the game from the players' bench, a Bench Minor penalty or a Penalty Shot shall be assessed under Rule 2.5 (e) or (f).*
- b) *For a player illegally entering the game from the penalty bench, a Minor penalty shall be assessed under Rule 9.5 (d).*
- c) *For a stick or any other object being thrown by a player of the defending team, a Minor penalty shall be assessed under Rule 9.8 (b).*
- d) *For the puck carrier being fouled from behind, a Minor penalty or, if injury results, a Major and Game Misconduct, shall be assessed under Rule 7.4 (a).*
- e) *For any member of the defending team, including team officials, whether on the players' bench or penalty bench, interferes by means of his body, stick or any other object with the puck or puck carrier, a Bench Minor penalty and a Game Misconduct shall be assessed under Rule 7.3 (d).*
- f) *For any member of the defending team deliberately removing his helmet or facial protector, or deliberately participating in the play without his helmet or facial protector, a Minor penalty shall be assessed under Rule 3.6 (c).*

#### SITUATION 3 Rule 4.10 (a) (2)

**QUESTION:**

*What happens if, in the course of being substituted for another player, the goaltender throws his stick at the puck carrier who has no other player (except the goaltender) between the goal and himself and the puck is in the neutral or attacking zone of the player on a break-away?*

**ANSWER:**

*If the goaltender is still on the ice and not yet substituted for an extra attacker, a Minor penalty shall be assessed to him if the player is in the neutral zone and the stick has been thrown from the side. The Referee shall not award a goal. Rule 9.8 (b). If the goaltender throws the stick from behind the player who is on a breakaway, and that player is fouled from behind and thus prevented from having a clear, unimpeded shot on goal, a Penalty Shot shall be awarded, even if the player is in the neutral or attacking zone. Rule 7.4 (d). If the puck or puck carrier is in the attacking zone (defending zone of the goaltender), a Penalty Shot shall be awarded under Rule 9.8 (a).*

*If the goaltender has already been legally substituted for within 3.05m (10 ft.) limit, the Referee shall award a goal under Rule 4.10 (a)(2).*

**SITUATION 4 Rule 4.10 (a)(2)**

*The goaltender has been removed and an opposing player gains possession and control of the puck on a breakaway in the neutral or attacking zone. The puck is knocked off the stick of the player in control by a stick thrown by a defending player. The attacking player is not interfered with and could regain possession of the puck easily.*

**QUESTION:**

*Should the Referee stop play immediately and award a Goal, or permit play to continue and only award a goal if the attacking player fails to score?*

**ANSWER:**

*Stop play immediately (regardless of whether the stick makes contact) and award the goal.*

**SITUATION 5 Rule 4.10 (a)(2)**

*The goaltender has been removed and an opposing player obtains a breakaway in the neutral or attacking zone. He shoots the puck towards the open goal. A defending player throws his stick at the shot puck.*

**QUESTION:**

*Do you award a goal?*

**ANSWER:**

*No. A goal may not be awarded as the player who shot the puck is no longer in control of the puck. Before a goal can be awarded the player must have both possession and control of the puck at the time of the infraction.*

**RULING:**

*The Referee would simply signal a penalty in the normal manner and if no goal is scored by the non-offending team he would assess a Minor penalty or award a Penalty Shot.*

- 1. If, at the moment the thrown stick reaches the puck, the puck is in the defending team's zone, a Penalty Shot shall be awarded under Rule 9.8 (a).*
- 2. If, at the moment the thrown stick reaches the puck, the puck is anywhere else on the ice, a Minor penalty shall be assessed under Rule 9.8 (b).*

**SITUATION 6 Rule 4.10 (c)**

*The goaltender is on the ice but away from his goal crease. A player of the opposing team takes possession and control of the puck and shoots it towards the open goal. As the puck is about to enter the open goal a defending player knocks the goal off its mooring(s).*

**QUESTION:**

*Do you award a goal?*

**ANSWER:**

No. No goal may be awarded as the goaltender is on the ice. The Referee would assess a Minor penalty for delaying the game. If this happens in the last two minutes of regular playing time, or any time in overtime, a Penalty Shot shall be awarded against the offending team, as per Rule 10.1 (c).

**SITUATION 7 Rule 4.10 (c)**

A goaltender in the act of proceeding to his players' bench deliberately places his stick or any portion thereof across the goal crease.

**QUESTION:**

What happens if the opposing team shoots the puck which hits the stick, preventing a goal;

- a) While the goaltender is still in the act of leaving the ice?
- b) When the goaltender is off the ice (or legally substituted for within the 3.05m (10 ft.) limit)?

**ANSWER:**

- a) A Minor penalty shall be assessed to the goaltender under Rule 7.3 (f), as the goaltender is still on the ice.
- b) A goal shall be awarded under Rule 4.10 (c).

**SITUATION 8 Rule 4.10 (c)**

A team has removed their goaltender in favour of an extra player. With the goaltender off the ice, an opponent, who has control of the puck in his attacking zone, shoots the puck towards the open goal. Subsequently, a defending player deliberately pulls or knocks the goal off its mooring(s), preventing a goal.

**RULING:**

Award a goal.

**GUIDELINES:**

1. The goal must be taken off its mooring(s).
2. The shot must be taken from anywhere on the ice and go into the area normally occupied by the goal. Note: If no shot is taken, or if the puck did not go into the area normally occupied by the goal, then no goal may be awarded. Where there is no goal awarded for this action, Rule 10.1 (c) - Delay of Game - must be applied.

**SITUATION 9**

No assist(s) shall be given on an Awarded Goal.

**SITUATION 10 Rule 4.10 (b)**

The puck is in the goal crease and the goaltender has been removed from the ice. A player bats or scoops the puck out of the crease. She does not cover or grab the puck while the puck is still in the crease, just scoops it out.

**RULING:**

- a) If the player does not close her hand on the puck or fall on it, just the scooping motion, assess no penalty.
- b) If the player then grabs it or falls on the puck once it is outside of the crease, assess a Minor penalty as per Rule 10.3 (c) and 9.1 (c).
- c) If the puck is clearly covered in the crease, either with a hand, or by falling on the puck, and this action prevents an obvious and imminent goal from being scored, award a goal.

**Rule 4.11 Goaltender Penalties**

- (a) No goaltender shall be sent to the penalty bench for an infraction which incurs a Minor, Major or Misconduct penalty. Instead, such a penalty shall be served by any player of her team who was on the ice at the time of the infraction. Such player shall be designated by the Manager or Coach of the penalized team through the Captain.

**NEW** **Unless the penalty being served is a time penalty, any player serving a penalty on behalf of a goaltender shall leave the penalty box if the offending goaltender is subsequently ejected from the game.**

- (b) An alternate goaltender may replace a regular goaltender who has been ejected from the game or has been assessed a Game Misconduct, Gross Misconduct or a Match penalty. In the event there is no alternate goaltender recorded on the playing line-up, the regular goaltender's place may be taken by any player on the Game Report designated by the Manager or Coach of the penalized team through the Captain. Such substitute will be allowed fifteen minutes to put on the full goaltender's equipment.
- (c) When a goaltender leaves her goal crease during a fight, she shall be assessed a Minor penalty, plus any other penalties she incurs.
- (d) When a goaltender leaves her goal crease to join in a fight, act as a peacemaker, or take part in another fight, during the same stoppage of play, she shall receive a Game Misconduct penalty, plus any other penalties she incurs.
- (e) If a goaltender intentionally participates in the play in any manner when she is beyond the centre red line, she shall be assessed a Minor penalty.
- (f) A Minor penalty shall be assessed a goaltender who, after catching the puck, drop kicks the puck. If injury results, a Major penalty and a Game Misconduct penalty shall be assessed.

**SITUATION 1 Rule 4.11 (a)**

*In ALL cases where a penalty is assessed to a goaltender requiring her team to send a player to the penalty bench to serve such penalty, the player designated to do so must have been on the ice at the time of the infraction. The following examples illustrate the application of this rule. Please note that in these examples, all players serving goaltender penalties must have been on the ice at the time of the infraction.*

**EXAMPLE A:**

*Team "A" 30 (goaltender) - 2*

*Team "A" plays one player short for 2 minutes.*

**EXAMPLE B:**

*Team "A" 30 (goaltender) - 2 + 2*

*Team "A" plays one player short for 4 minutes.*

**EXAMPLE C:**

*Team "A" 30 (goaltender) - 5 + GM + 2*

*Team "A" plays one player short for 7 minutes.*

*As the goaltender is assessed a Game Misconduct, the substitute goaltender must enter the game without delay and no warm-up shall be permitted, as stated in Rule 2.2 (f).*

**EXAMPLE D:**

*Team "A" 30 (goaltender) - 5 + GM*

*Team "B" 14 - 5 + GM*

*No player serves 5 minute penalty for goaltender. As the coincidental penalty rule is applied, neither team plays short. No substitute for either player as both receive automatic Game*

*Misconducts. As the goaltender is assessed a Game Misconduct, the substitute goaltender must enter the game without delay and no warm-up shall be permitted, as stated in Rule 2.2 (f).*

**EXAMPLE E:**

*Team "A" 30 (goaltender) - 5 + GM + 10*

*Team "B" 14 - 5 + GM*

*As the coincidental penalty rule is applied, neither team plays short. No substitute for either player as both receive automatic Game Misconducts. As the goaltender is assessed a Game Misconduct, the substitute goaltender must enter the game without delay and no warm-up shall be permitted, as stated in Rule 2.2 (f).*

**EXAMPLE F:**

*Team "A" 30 (goaltender) - 5 + GM + 2*

*Team "B" 14 - 2*

*A player serves the goaltender's Major penalty with Team A playing short for 5 minutes. As the goaltender is assessed a Game Misconduct, the substitute goaltender must enter the game without delay and no warm-up shall be permitted, as stated in Rule 2.2 (f).*

**EXAMPLE G:**

*Team "A" 30 (goaltender) - 5 + GM*

*Team "A" plays one player short for 5 minutes.*

*As the goaltender is assessed a Game Misconduct, the substitute goaltender must enter the game without delay and no warm-up shall be permitted, as stated in Rule 2.2 (f).*

**SITUATION 2 Rule 4.11 (c)(d)**

**QUESTION:**

*If a goaltender who leaves the vicinity of her goal crease during a fight is the first player to intervene on that fight, what penalties is she assessed?*

**ANSWER:**

*A Minor penalty for leaving the goal crease, plus a Game Misconduct for being the third man to enter a fight, plus any other penalty (penalties) she may receive under the rules.*

**SITUATION 3 Rule 4.11 (e)**

**QUESTION:**

*A goaltender whose skates are over the centre red line plays the puck which is still on her own team's side of the centre red line. Is this legal?*

**ANSWER:**

*No. The determining factor is the position of the goaltender's skates and not the position of the puck. Assess the goaltender a Minor penalty for "Ineligible Player".*

**Rule 4.12 Delayed Penalties**

- (a) If a third player of any team shall be penalized while two players of the same team are serving penalties, the penalty time of the third player shall not commence until the penalty time of one of the two penalized players has elapsed. Nevertheless, the third player penalized must at once proceed to the penalty bench, but shall be replaced on the ice by a substitute until such time as the penalty time of the penalized player shall commence.
- (b) When a team has three players serving penalties at the same time and while due to the delayed penalty rule a substitute for the third player is on the ice, none of the three penalized players on the penalty bench may return to the ice until play has been

stopped. When the play has been stopped, the player whose full penalty has expired may return to the play.

- (c) When the penalties to the player or players have expired and the penalized team is entitled to more than four players on the ice, the Penalty Timekeeper shall permit the penalized players to return to the ice in the order of the expiry of their penalties.

**NEW**

**When the penalties of two players from the same team expire at the same time and that team is entitled to only one additional player on the ice the players shall return to the ice in the order in which their penalties were reported.**

- (d) In cases where Minor penalties are assessed at the same time to more than one player from the same team, those penalties shall be served in order of occurrence. Rule 4.12 (d) does not apply when the coincident Minor penalty rule is applied.
- (e) When a Major penalty and a Minor penalty are assessed at the same time against two different players of the same team, the Penalty Timekeeper shall record the Minor as being the first penalty assessed. (See Rule 4.1 (e)).

**SITUATION 1 Rule 4.12 (c)**

A 4 - 2	8:00
A 6 - 2	7:20
A 8 - 2	7:00

**QUESTION:**

Assuming that no goals are scored by the opposing team during the above situation and there are no play stoppages after 7:00, at what time would each Team "A" player come back on the ice from the penalty bench?

**RULING:**

As per Rule 4.12 (c), when the penalties to the player or players have expired and the penalized team is entitled to more than four players on the ice, the Penalty Timekeeper shall permit the penalized players to return to the ice in the order of expiry of their penalties.

**SOLUTION:**

In this situation or any similar one, it may be advantageous for the On-ice and Off-ice Officials to break down the various critical times as follows:

Player No.	Time	Off	Start	End	On
A 4	2:00	8:00	8:00	6:00	5:20
A 6	2:00	7:20	7:20	5:20	4:00
A 8	2:00	7:20	6:00	4:00	1st stoppage after 4:00

Note: Players A4 and A6 would return to the ice earlier if there is a stoppage of play after the expiry of their own penalty.

**Rule 4.13 Calling of Penalties**

- (a) If a player on the team in possession of the puck commits an infraction of the rules which would call for a Match, Major, Misconduct, Bench Minor or Minor penalty, the Referee shall blow her whistle immediately and give the penalty(ies) to the deserving player(s). The resulting face-off shall be where the play was stopped, unless the stoppage occurred in the offending player's attacking zone, in which case the face-off is brought out to the neutral zone.
- (b) If a player on the team not in possession of the puck commits an infraction of a rule which would call for a Match, Major, Misconduct, Bench Minor or Minor penalty, the



Referee shall signal the penalty by extending her arm straight up. The Referee shall blow her whistle and stop play immediately when the offending team gains possession and control of the puck.

The resulting face-off shall be where the play was stopped, unless during the period of the delayed penalty call against the team not in possession, the team in possession ices the puck, shoots the puck from its own zone so that it goes out of bounds or is unplayable, then the face-off following the stoppage of play shall take place at the face-off spot in the neutral zone nearest the defending blue line of the team shooting the puck.

If the penalty to be assessed is a Minor or Bench Minor penalty and a goal is scored on the play by the non-offending team, the Minor penalty shall not be assessed, but OTHER Minor, Bench Minor, Major, Match and Misconduct penalties shall be assessed in the normal manner, regardless of a goal being scored.

*Note: If after the Referee has signalled a penalty, but before the whistle has been blown, a member of the non-offending team shall put the puck in her own net in any manner through no contact by the offending team, the goal shall be allowed and the penalty signalled shall be assessed in the normal manner.*

*If the Referee signals a Minor or Bench Minor penalty(ies) against a team that is shorthanded by reason of one or more Minor or Bench Minor penalties, and a goal is scored by the non-offending side before the whistle is blown, the goal shall be allowed and the player who is serving the first Minor or Bench Minor penalty will return to the ice, while the signalled penalty(ies) shall be assessed and served in the normal manner. **If the Referee signals a delayed penalty calling for a Penalty Shot against a team that is shorthanded and a goal is scored by the non-offending team before play is stopped, the goal shall be allowed. If the infraction associated with the Penalty Shot would normally call for a Minor or Major or Match penalty, then a Minor / Major / Match penalty shall be assessed in lieu of the Penalty Shot.***

## NEW

- (c) If further infractions are committed by the same offending player, either before or after the Referee blows her whistle, that player shall serve the penalties consecutively.
- (d) The Referee has the right to stop play immediately in the case of a Match penalty. The resulting face-off will be where the play was stopped, unless the stoppage occurred in the offending player's attacking zone, in which case the face-off is brought out to the neutral zone.

### SITUATION 1 Rule 4.13 (a)(b)

*Where the Referee is about to blow the whistle to assess a penalty (or penalties to both teams) and a goal is scored by the offending team (or any team, in the case of penalties to both teams) before the Referee is able to get the whistle to her mouth to stop play, such goal shall not be allowed.*

#### REASON:

*Unless the team without the puck committed the infraction, play in theory should be stopped immediately. In certain cases, the normal reaction time of an official would not enable her to stop play before a goal is scored. However, no goal would be allowed if the infraction occurred before the goal was scored.*

### SITUATION 2 Rule 4.13 (b)

#### QUESTION:

*On a delayed penalty call to a player who is about to be assessed a Major plus an auto-*

*matic Game Misconduct plus a Minor, the non-offending team scores a goal. Is any penalty washed out?*

**ANSWER:**

*The Minor penalty is washed out and a player from the ice will serve the Major penalty. The order in which the two penalties were to be assessed has no effect on whether or not the Minor should be washed out.*

**SITUATION 3 Rule 4.13 (b)**

**QUESTION:**

*A delayed penalty is signaled against Team "A". A subsequent infraction by Team "A" calling for a Bench Minor penalty is observed by a Linesman. What signal is to be employed by the Linesman and what procedure does she follow?*

**ANSWER:**

*No signal is employed. The Linesman cannot stop play to assess the penalty. She shall report the infraction to the Referee upon the first stoppage of play.*

**SITUATION 4 Rule 4.13 (b)**

**QUESTION:**

*Team "A" has a player serving a Minor penalty (time penalty). The Referee signals a delayed penalty against a player of Team "A". Another player on Team "A" throws her stick at the puck in her own defending zone. Team "B" scores a goal before play is stopped. Is a Penalty Shot awarded ?*

**ANSWER:**

*No. The scoring of the goal by Team "B" terminates the Minor penalty being served by Team "A". The delayed penalty against Team "A" as well as a Minor penalty for throwing the stick (in lieu of a Penalty Shot) shall be assessed.*

**SITUATION 5 Rule 4.13 (b)**

*Where there are delayed Minor penalties to two different players of the same team to be called, but a goal is scored against that team before the next stoppage of play, the Referee shall designate which penalty is to be assessed and which of the two Minor penalties is to be washed out, based on the order of occurrence of the two infractions, as covered in Rule 4.12 (d).*

**SITUATION 6 Rule 4.13 (b)**

*As a Referee, you have a delayed penalty signaled against No. 6 of Team "A" and you are going to award a Penalty Shot as a result of that infraction. Before play is stopped, No. 6 commits another infraction calling for a Minor penalty.*

**QUESTION:**

*What is the Referee's decision if:*

- a) Team "B" scored before the play is stopped?
- b) Team "B" does not score before the play is stopped?
- c) Team "B" scores on the Penalty Shot?

**ANSWER:**

- a) Wash out the Penalty Shot but assess the Minor.
- b) Award the Penalty Shot and assess the Minor.
- c) Assess the Minor.

**SITUATION 7 Rule 4.13 (b)**

*A delayed penalty is to be called against Team "A". Team "B" scores before the stoppage of play. Team "A" requests a measurement of the stick of the player on Team "B" scoring the goal.*

**RULING:**

*A stick measurement with the subsequent appropriate penalty is permitted after the scoring of a goal. (Section Three - Equipment, Measurement Guidelines #6). The goal will be allowed and the delayed penalty on Team "A" will be washed out. In no way can the Referee wash out the Minor penalty for "Delay of Game" for unsubstantiated stick measurement for "Illegal Stick".*

**SITUATION 8 Rule 4.13 (b)****QUESTION:**

*The Referee has signaled a delayed double Minor penalty to Team "A" 14 (for spearing). Team "B" scores before play is stopped. Is any penalty washed out?*

**ANSWER:**

*The scoring of the goal by Team "B" washes out one of the Minor penalties. The second one will be served as usual and shall be recorded on the Official Game Report as a Minor penalty.*

**SITUATION 9**

*Team "A" #10 receives a Minor penalty at 4:30. Team "B" #4 receives a Minor penalty at 3:30. The Referee signals a delayed Minor penalty against Team "A" #6. Team "B" scores at 3:00 before the Referee can stop play to assess the delayed Minor penalty to Team "A" #6.*

**QUESTION:**

*Is the delayed penalty to Team "A" #6 washed out as a result of Team "B's" goal?*

**ANSWER:**

*Yes. Team "A" is not considered to be "shorthanded" and therefore the delayed Minor penalty to Team "A" #6 would not be assessed as a result of the goal being scored by Team "B".*

**SITUATION 10 Rule 4.13 (b) - Note 2****QUESTION:**

*The Referee has signaled a delayed penalty to a player of Team "A" and Team "B" has substituted its goaltender in favour of an extra attacker. A player of Team "B" shoots the puck which hits a player of Team "A" and then deflects down the ice into Team "B"'s goal. Does the Referee allow the goal?*

**ANSWER:**

*NO GOAL. The puck entered the goal as a result of contact by the offending team.*

**SITUATION 11 Rule 4.13 (b) - Note 2****QUESTION:**

*A delayed penalty is signaled against a player of Team "A". Team "B" pulls their goaltender in favour of an extra attacker player. A player of Team "B" passes to a teammate. The pass contacts a player of Team "A" and the puck goes into the open goal. Is the goal allowed?*

**ANSWER:**

*NO GOAL. The puck entered the net as a result of contact by the offending team.*

**SITUATION 12 Rule 4.13 (b) - Note 2****QUESTION:**

*A delayed penalty is signaled against a player of Team "A". Team "B" pulls their goaltender in*

*favour of another attacking player. As a player of Team "B" skates in front of her net with the puck, she is stick-checked by a player of Team "A" and the puck enters the goal. Is the goal allowed?*

**ANSWER:**

**NO GOAL.** The puck entered the net as a result of contact by the offending team.

**SITUATION 13** Rule 4.13 (b) - Note 2, Rule 10.4 (b)

**QUESTION:**

*Can a player against whom a delayed penalty is signaled be credited with the scoring of a goal?*

**ANSWER:**

*Yes, where a player of the non-offending team shoots the puck into her own goal without any contact by the offending team and the player to be assessed the penalty was the last player on the offending team to touch the puck.*

**SITUATION 14**

**QUESTION:**

- 1. How do you record on the Official Game Report a player who receives a Minor, a Misconduct, a Game Ejection, a Game Misconduct, a Gross Misconduct and then a Match penalty?*
- 2. How much time shows on her penalty time record?*

**ANSWER:**

- 1. As far as the Official Game Report is concerned, the Official Scorer would make one entry for each penalty and a substitute player would be required to serve the time penalties for the Minor and the "5 minutes" for the Match penalty.*
- 2. On the player's penalty time record, the time would show 2 minutes for the Minor, 10 minutes for the Misconduct, 10 minutes for the Game Misconduct, 10 minutes for the Gross Misconduct and 5 minutes for the Match penalty. No time would be recorded for the Game Ejection penalty.*

**SITUATION 15**

*Where a Referee has signaled a penalty and has been unable to identify the offending player's number, the Referee in consultation with the Captain will choose a player who was on the ice at the time of the infraction to serve the penalty.*

**SITUATION 16**

*A player is injured by a high stick. This action is observed by the Linesman, but not the Referee. The Linesman is unable to identify the offending player.*

*Ruling: The Referee, after consulting with the Captain of the offending team, shall select a player to serve the Major penalty and a second player who will receive the Game Misconduct. Both players selected shall be from the ice at the time of the infraction (The Referee should make every attempt to determine the identity of the guilty player before consulting the Captain).*

**EXAMPLES OF MINOR PENALTIES**

- |     |  |   |
|-----|--|---|
| 1.  | Team "A" 6-2 at 4:00<br>Team "A" 9-2 at 3:00<br>Team "A" 6 returns               | Team "B" 11-2 at 3:30<br>Team "B" scores at 2:30    |
| 2.  | Team "A" 6-2 at 4:00<br>Team "A" 9-5+GM at 3:00<br>Team "A" 6 returns            | Team "B" 11-2 at 3:30<br>Team "B" scores at 2:30    |
| 3.  | Team "A" 6-5+GM at 4:00<br>Team "A" 9-2 at 3:00<br>Team "A" 9 returns            | Team "B" 11-2 at 3:30<br>Team "B" scores at 2:30    |
| 4.  | Team "A" 6-2 at 3:30<br>Team "A" 9-2 at 3:00<br>Team "A" 6 returns               | Team "B" 11-2 at 4:00<br>Team "B" scores at 2:30    |
| 5.  | Team "A" 6-2 at 4:00<br>Team "A" 9-2 at 3:30<br>Team "A" 6 returns               | Team "B" 11-2 at 3:15<br>Team "B" scores at 3:00    |
| 6.  | Team "A" 6-2 at 4:00<br>Team "A" 9-5+GM at 3:30<br>Team "A" 6 returns            | Team "B" 11-2 at 3:00<br>Team "B" scores at 2:30    |
| 7.  | Team "A" 6-5+GM at 4:00<br>Team "A" 9-2 at 3:30<br>Team "A" 9 returns            | Team "B" 11-2 at 3:00<br>Team "B" scores at 2:30    |
| 8.  | Team "A" 6-2 at 4:00<br>Team "A" 9-2 at 3:00<br>Team "A" 9 returns               | Team "B" 11-2 at 4:00<br>Team "B" scores at 2:30    |
| 9.  | Team "A" 6-5+GM at 4:00<br>Team "A" 9-2 at 3:30<br>Team "A" 9 returns            | Team "B" 11-2 at 4:00<br>Team "B" scores at 2:30    |
| 10. | Team "A" 6-5+GM at 4:00<br>Team "A" 9-2 at 3:30<br>No player on Team "A" returns | Team "B" 11-2 at 3:30<br>Team "B" scores at 2:30    |
| 11. | Team "A" 6-5+GM at 4:00<br>Team "A" 7-2 at 3:30<br>Team "A" 7 returns            | Team "B" 11-5+GM at 3:30<br>Team "B" scores at 2:00 |
| 12. | Team "A" 6-2 at 4:00<br>Team "A" 7-2 at 3:30<br>Team "A" 6 returns               | Team "B" 11-5+GM at 4:00<br>Team "B" scores at 3:00 |

**EXAMPLES OF COINCIDENT - MAJOR/MATCH PENALTIES**

<b>PLAYERS</b>					
<b>EXAMPLES</b>	<b>W</b>	<b>X</b>	<b>Y</b>	<b>Z</b>	<b>REMARKS</b>
No. 1 TEAM A TEAM B	♣+GM	♣+GM			Immediate substitution for W and X
No. 2 TEAM A TEAM B	② ♣+GM	♣+GM			Players from ice serves Player W minor, Team A short for 2 minutes
No. 3 TEAM A TEAM B	♣+GM	♣+GM	♣+GM	♣+GM	Immediate substitution for W, X, Y and Z
No. 4 TEAM A TEAM B	♣+GM ⑤+GM	♣+GM			Team A plays shorthanded for five minutes, immediate substitution for X
No. 5 TEAM A TEAM B	② ♣+GM	♣+GM	♣+GM	♣+GM	Team A plays shorthanded for 2 minutes, immediate substitution for X, Y, and X.
No. 6 TEAM A TEAM B	℥ ♣+GM	℥ ♣+GM			Immediate substitution for W and X.
No. 7 TEAM A TEAM B	5+GM	5+GM		5+GM	Team B plays shorthanded for five minutes. Immediate substitution for W and either X or Z (order of occurrence).
No. 8 TEAM A TEAM B	℥ ♣+GM	℥ ② ♣+GM			Substitution for X after 2 min. Immediate substitution for W.
No. 9 TEAM A TEAM B	℥	℥ ♣+GM	♣+GM		Immediate substitution for W, X and Y.

## EXAMPLES OF COINCIDENT - MAJOR/MATCH PENALTIES

PLAYERS					
EXAMPLES	W	X	Y	Z	REMARKS
No. 10 TEAM A	Z Z+GM	Z Z+GM	② ② Z+GM	Z+GM ⑤+GM	Substitution for either X or Z after 5 min. (order of occurrence). Substitution for Y after 4 min. Immediate substitution for W and X or Z (order of occurrence).
TEAM B					
No. 11 TEAM A	Z Z+GM	Z ② ⑤+GM	Z+GM	Z+GM Z+GM	Substitution for X after 7 min. Immediate substitution for W, Y and Z.
TEAM B					
No. 12 TEAM A	②	Z	Z Z	Z	Substitution for W after 2 min. Immediate substitution for X, Y, and Z.
TEAM B					

Criteria for using both coincidental minors and majors "MOTO"

- 1) **M** Cancel as **M**any penalties as possible.
- 2) **O** Cancel in a way to make them only **O**ne player short.
- 3) **T** Cancel in a way to avoid **T**aking an extra player off the ice.
- 4) **O** Cancel using the order of **O**ccurrence, or the order that the penalties were reported by the Referee.

*Note: Start by cancelling majors, then do minors.*

# ACME

Specialist whistles since 1870

## FIRST AND FOREMOST EVER SINCE

477/58.5

Tapered mouthpiece,  
classic sound and  
strength



477/58

The original square  
mouthpiece, tough with  
powerful deep tone



577

Large, polycarbonate  
square mouth,  
deep tone

The world's first specially  
designed Ice Hockey Whistles  
were created by ACME. Developed  
over time, the modern whistle is  
still hand made and individually  
tested. Independent tests have confirmed  
Acme's place as the undisputed No.1  
performing whistle.

*Don't settle for less*

246/60.5

Glove-Grip™  
Any position,  
any glove  
Patent Pending





## SECTION 5 OFFICIALS

### **Rule 5.1 Appointment of Officials**

- (a) For inter-branch play-off games, the President of Hockey Canada or his duly appointed representative shall appoint one Referee and two Linesmen. He shall also appoint a Game Timekeeper, a Penalty Timekeeper, an Official Scorer and two Goal Judges.
- (b) Referees, Linesmen and Off-ice Officials shall be treated with courtesy at all times by players and team officials. Any infraction of this rule will be reported to the President, who may assess such penalties as the infraction warrants.
- (c) Branches may use a Referee and Assistant Referee or a Referee and one or two Linesmen or the four man system for games within their own Branches.
- (d) A Referee shall have full authority and the final decision in all matters under dispute. His decision shall be final on all questions of judgement and not subject to appeal.
- (e) A Referee shall not be used in any Hockey Canada play-offs unless recommended in writing by his Branch through their President, to Hockey Canada's Officer in charge.
- (f) For inter-branch play-off games, only Level V & VI certified Referees shall be appointed, but for National Championships and designated IIHF competition, the Referee shall be a certified Level VI Referee. This does not necessarily apply to Minor or Female Hockey. For inter-branch play-off games, only Level V & VI Standby Officials shall be appointed. They shall replace any of the appointed game officials, should one of them become ill or injured. They will also be responsible for supervising the pre-game warm-up and will report to the Referee in charge of the game any incident requiring the assessment of penalties.
- (g) All Referees operating within the jurisdiction of Hockey Canada shall be affiliated and under the control of the Branch in which they are officiating.

### **Rule 5.2 Referee and Linesmen**

- (a) The Referee and two Linesmen are the official representatives of Hockey Canada or Branch of Hockey Canada in which the game is being played. They shall be in full control of the players on and off the ice. Off-ice Officials and the Officials connected with the competing clubs and the Referee will be backed to the limit in all legitimate circumstances.
- (b) The Referee shall see that the teams are called to the ice at the appointed time for the commencement of each game, and at the start of each regulation and overtime period. The Referee shall remain on the ice at the conclusion of each period, and any overtime, until the players have proceeded to their dressing rooms.
- (c) The Referee shall check the equipment worn by any player when requested to do so by the Manager or Coach of either team through the Captain on the ice.
- (d) The Referee shall assess all penalties as prescribed by the rules for infractions thereof.
- (e) The Referee shall give the final decision in the matter of disputed goals, after having consulted with the Linesmen and the Goal Judge involved.
- (f) Before starting the game, the Referee shall see that the appointed Game Timekeeper, Penalty Timekeeper, Official Scorer and Goal Judges are in their respective positions.
- (g) The Referee shall announce to the Official Scorer the duration of the penalties and the rule infractions involved, and also to whom the goals and assists are credited.

- (h) The Referee shall, when possible, see that players of the opposing teams are separated on the penalty bench to prevent feuding.
- (i) After each game, the Referee shall check and sign the Official Game Report and return it to the Official Scorer.
- (j) Should an official accidentally leave the ice, or receive an injury which would affect her duties while play is in progress, the play shall be stopped.
- (k) If for whatever reason, the Referee or Linesmen appointed are prevented from appearing, the Managers or Coaches of the two competing clubs shall agree on a Referee and one or two Linesmen. If they are unable to agree, they shall appoint a player from each team who shall act as officials.
- (l) If the regularly appointed officials appear during the progress of the game, they shall replace the temporary officials immediately.
- (m) If a Linesman appointed is unable to act at the last minute, or if through sickness or accident, she is unable to finish the game, the Referee in charge shall have the power to appoint another in her place, if she feels it is necessary.
- (n) If owing to illness or accident, the Referee is unable to continue to officiate when working with two Linesmen, one of the Linesmen shall perform such duties as devolved upon the Referee. The Linesman shall be selected by the Referee, or if necessary, by the Managers or Coaches of the competing teams.
- (o) The Referee in charge and the Linesmen shall be thoroughly impartial parties.
- (p) While on the ice, all Referees and Linesmen shall be garbed in black trousers, a sweater with a branch or league crest sewn on, and wear a CSA certified hockey helmet, preferably black in colour and a CSA certified visor. Helmets shall be removed during the playing of the national anthem(s). During all inter-branch play-off games and international competition, Referees and Linesmen shall be garbed in black trousers, a black and white striped sweater with either the Branch or Hockey Canada crest sewn on, and wear a black CSA certified helmet and a CSA certified visor.  
*Note: The Referee in the three-man system shall wear a six inch red arm band or a four inch arm band with a one inch black stripe on each side of the band, on each arm above the elbow.*

- (q) Referees are required to report on the Official Game Report or separate Penalty Report Form, all Match, Gross Misconduct and Game Misconduct penalties, immediately following the game, giving full details to the President. During inter-branch competition, the Referee is required to phone Hockey Canada's Officer in charge of discipline, immediately following the game.

- NEW** (r) **Linesmen shall check the goal, netting, and the ice in and around the goaltender's crease before the start of each period.** The Referee shall check the goal lights, timing device, and ice markings. If the ice markings are not in accordance with Hockey Canada Rules, it must be reported to the President.
- (s) The official method of refereeing Hockey Canada hockey games is with a Referee and two Linesmen. However, Branches are authorized to use two Referees or the four man system for games under their jurisdiction.
  - (t) When reference is made to the Linesmen under Rules 5.2 and 5.3 (all clauses), the duties of the Linesmen will be carried out by both Referees.

**SITUATION 1 Rule 5.2 (e)**

*As the rule states, the Referee shall give the final decision in the matter of disputed goals. It is up to the Referee's discretion whether or not she consults the Linesmen or Goal Judge. This means the Referee is not required to consult any other official in matters related to a disputed goal, if she is certain of her decision.*

**Rule 5.3 Linesmen**

- (a) The Linesmen shall have the authority to stop play when:
    - (1) off-side violations occur at the blue line or when icing violations occur.
    - (2) the puck goes outside the playing surface or when it is interfered with by an ineligible person.
    - (3) more than the correct number of players are on the ice and the team committing the infraction has possession of the puck.
    - (4) the puck has been illegally batted with the hand from one player to a teammate.
    - (5) a player strikes the puck with a high stick and it has become obvious the Referee did not observe this infraction.
    - (6) the goal net has been displaced from its normal position and the Referee has not observed this situation.
    - (7) it appears that a player has sustained a serious injury.
  - (b) The Linesmen shall report to the Referee at the first stoppage when more than the correct number of players are on the ice and the team committing the infraction does not have possession of the puck.
  - (c) Linesmen shall face-off the puck at all times, except at the start of the game, at the start of the period, and after each goal has been scored.
  - (d) Linesmen shall point out the offender and report to the Referee at the first stoppage, their version of any infraction of the rules which calls for a Minor, Bench Minor or double Minor penalty for Rules
    - 1.9 (d),
    - 2.5 (e)(g), (Section Three),
    - 3.6 (b) (Note 4),
    - 6.1 (b) (Head-butting),
    - 6.1 (d) (Grabbing/pulling hair or head/facial protection),
    - 7.3 (c)(d),
- NEW** **8.1 (Butt-ending),**  
**8.3 (b) (High Sticking double Minor) in Junior and Senior only,**  
**8.5 (Spearing),**  
 9.2 (b),  
 9.2 (c),  
 9.2 (h),  
 9.5 (b)  
 9.5 (i),  
 10.1 (a),  
 10.1 (f),  
 10.15 (e),

as well as any infraction which calls for a Major or Match penalty or any conduct calling for a Bench Minor, Misconduct, Game Misconduct or Gross Misconduct Penalty,

- (e) Linesmen shall, when requested by the Referee, give their version of any incident that may have taken place during the game.
- (f) Linesmen shall, if safe to do so, remove the broken portions of sticks left on the ice.

#### SITUATION 1

*Linesmen have the authority to stop play when:*

1. *An off-side situation arises.*
2. *An off-side pass situation arises.*
3. *An icing the puck situation arises.*
4. *There has been premature entry into the face-off circle.*
5. *The puck goes outside the playing area.*
6. *The puck is interfered with by an ineligible person.*
7. *The puck has been batted with the hand from one player to a teammate and it has become obvious the Referee has not seen the infraction.*
8. *The puck has been struck with a high stick and it has become obvious the Referee has not seen the infraction.*
9. *There are too many players on the ice. If it is a delayed penalty, the Linesman shall stop play when the offending team gains possession and control of the puck, but the Linesman shall NOT raise his arm in this situation.*
10. *The goal has been displaced from its normal position and the Referee has not observed this situation. The Linesman shall follow the guidelines specified in Situation 2 of this rule and in Situation 1 of Rule 10.1 - Delay of Game.*
11. *There has been a premature substitution of a goaltender.*
12. *The Referee is injured or accidentally leaves the ice, preventing him from performing his duties.*
13. *It is obvious that a player has sustained a serious injury and the Referee has not seen this situation.*

#### SITUATION 2

*Linesmen should report the following infractions to the Referee, at the first stoppage of play:*

1. *A player who is interfered with by a spectator.*
2. *A player who illegally enters the game from his own players' or penalty bench.*
3. *A stick thrown on the ice from the bench.*
4. *A player who deliberately displaces the goal.*
5. *An infraction of the rules, which incurs a double Minor penalty for Rules 6.1 (b), 8.1, 8.3 & 8.5 or a minor penalty for Rule 6.1 (d), as well as any infraction which incurs a Major or Match penalty, or any conduct calling for a Bench Minor, Misconduct, Game Misconduct, or Gross Misconduct.*

#### SITUATION 3 Rule 5.3 (b)

*Linesmen are to stop play when more than the correct number of players are on the ice, but must still follow the regular procedure for calling penalties. If the offending team has control*

*of the puck, the Linesmen shall stop play immediately; however, if the offending team does not have control, it then becomes a delayed call. In both situations, the Linesmen must report the infraction to the Referee at the first stoppage of play. Note: There is no signal that the Linesman should use in the delayed penalty situation.*

**SITUATION 4 Rule 5.3 (d)**

**QUESTION:**

*Can a Linesman report a double Minor penalty for spearing, butt-ending, head-butting, or situations calling for a minor penalty for grabbing of hair, facial protector, helmet or chin strap.*

**ANSWER:**

*Yes, the Linesman shall report the foul to the Referee at the first stoppage of play at which time the Referee may assess the penalty.*

**SITUATION 5 Rule 5.3 (d)**

**QUESTION:**

*Can a Linesman award a Penalty Shot where a player is fouled from behind on a breakaway in the neutral or attacking zone and the Referee has not observed the infraction? (The Linesman would report the foul to the Referee at the first stoppage of play).*

**ANSWER:**

*No.*

**SITUATION 6 Rule 5.3 (d)**

**QUESTION:**

*A Linesman is about to report a penalty (Minor 6.1 (d) Bench Minor, double Minor, Major, Misconduct, Game Misconduct, Gross Misconduct, or Match), but before he does so, the offending team scores a goal. What procedure does the Referee follow?*

**ANSWER:**

*The Referee washes out the goal, as the infraction occurred before the goal was scored.*

**RULING:**

*Linesmen do not stop play, but must wait for the first stoppage of play to report their version to the Referee. Therefore, if the infraction occurs before the goal is scored, this infraction shall be pointed out to the Referee who would wash out the goal and assess the penalty.*

**SITUATION 7**

*A goal is scored. Before the play resumes the Linesman notifies the Referee that the play should have been called for icing.*

**RULING:**

*The Referee shall disallow the goal and the face-off shall take place at the end face-off spot where the face-off for the icing should normally taken place. Note: The same theory would apply if the Linesman were to notify the Referee that an off-side at the blue line had taken place, but was not called prior to the goal. The goal would be disallowed and the face-off would take place at the spot where the normal face-off would be, as covered by the appropriate rules.*

**Situation 8 Rule 5.3 (d)**

**QUESTION:**

*Can a Linesman report a "Checking from Behind infraction?"*

**ANSWER:**

*The Linesmen can only report an infraction that calls for a Major or Match penalty for*

*“Checking from Behind”, but not for a Minor penalty. The Linesman shall report the infraction to the Referee at the first stoppage of play, at which time the Referee may assess the penalty.*

#### **Rule 5.4 Goal Judges**

- (a) There shall be one Goal Judge behind each goal. The Goal Judges shall not be members of either competing team, nor shall they be replaced during the progress of the game, unless it becomes apparent that either Goal Judge, on the account of partisanship or any other cause, is guilty of giving unjust decisions. In such cases, the Referee in charge may appoint another Goal Judge to act in her place.
- (b) Each Goal Judge shall be stationed in the designated area behind each goal for the duration of the game, and she shall not change ends at any time after the game begins. Her jurisdiction is limited to that game only.
- (c) In the event of a goal being claimed, the Goal Judge shall decide whether or not the puck has passed between the goal posts and entirely over the goal line. Her decision will simply be “goal” or “no goal”.

#### **Rule 5.5 Penalty Timekeeper**

- (a) The Penalty Timekeeper shall keep the time served by each penalized player during the game and, upon request, inform the penalized player as to the unfinished time of his penalty.
- (b) If a player leaves the penalty bench before his time has expired, the Penalty Timekeeper shall note the time and signal that to the Referee, who will stop the play as soon as possible.
- (c) Where public address systems are used, the Penalty Timekeeper shall announce or have announced the name of each penalized player, the nature of the offence and the time the penalty was assessed.

#### **Rule 5.6 Official Scorer**

- (a) The Official Scorer shall enter on the “Official Game Report” a correct record of the goals scored, by whom they were scored and to whom assists, if any, are to be credited. She shall also keep a correct record of all penalties assessed, stating the names and numbers of the penalized players, the duration of the penalty, the infraction, and the time when the penalties were assessed.
- (b) The Official Scorer shall request that all affiliated players dressed for the game, be designated on the Official Game Report by the use of the symbols “AP” after their name (in a similar manner to that used to designate the Captain and Alternate Captains). They shall be players not signed to a regular card of the club with which they are playing.
- (c) At the completion of each game, the Official Scorer shall sign the Official Game Report herself, and then have the Referee sign it.  
She shall then forward the Game Report to the Secretary of the branch or league involved.
- (d) Prior to the start of the game, the Official Scorer shall obtain from the Manager or Coach of each team their complete lineups, verified and signed by the TEAM OFFICIAL

IN CHARGE. The Captain and Alternate Captains of each team shall be duly noted on the Official Game Report.

- (e) The Official Scorer shall submit the complete line-up of the competing teams to the Referee, in her dressing room prior to the start of the game and shall draw to her attention any case which she feels does not comply to the rules.
- (f) The Official Scorer shall advise the Referee when the same player has received her second Misconduct penalty, or her third stick infraction penalty (as per Rule 4.2 (e)) during the same game.
- (g) Where a public address system is in use, the Official Scorer shall announce, or have announced, immediately following the scoring of each goal, the name of the player who scored the goal and the name of each player who received an assist.

#### SITUATION 1 Rules 5.6 (f)

*A player is assessed a Major penalty, second Misconduct or third stick infraction penalty during the same game. However, that player has not been assessed a Game Misconduct (Major Penalties or Rule 4.5 (c) - Misconduct Penalties) or a Game Ejection penalty (as required by Rule 4.2 (e) - Minor Penalties). This may be due to the fact that:*

- a) *The Official Scorer failed to notify the Referee that the player had been assessed a second Misconduct or third stick infraction penalty, as required by Rule 5.6 (f) - Official Scorer*
- b) *The Referee is not aware of the fact that the player has received the two Misconduct's, or the three stick infraction penalties in the same game.*

*The important fact is that the player penalized in this manner has not been assessed the appropriate Game Misconduct or Game Ejection penalty and therefore is in the game ILLEGALLY. If this situation is brought to the Referee's attention prior to the completion of the game, the following procedures apply:*

- i) *Assess the Game Misconduct or the Game Ejection penalty at the time this fact is brought to your attention.*
- ii) *Any goal(s) scored by the player so penalized following her return from serving her second Misconduct or third stick infraction penalty is (are) to be washed out. Any goal on which the penalized player received an assist following her return from these penalties is to be washed out.*

*Note: No goal is to be washed out if this is brought to the attention of the Referee after the completion of the game, but it should still be noted on the Official Game Report.*

#### **Rule 5.7 Game Timekeeper**

- (a) The Game Timekeeper shall record the start and finish time of each game and all actual playing time during the game.
- (b) The Game Timekeeper shall signal the Referee for the commencement of the game, the start of the second and third period and for each overtime period. If the rink is not equipped with an automatic sound device, or if this equipment should fail to operate, the Game Timekeeper shall, by means of a siren or whistle, signal the end of each period, each overtime period and the end of the game.
- (c) The Game Timekeeper shall announce or have announced when ONE MINUTE of actual playing time remains in each regulation or overtime period.

- (d) In the event of any dispute regarding time, the matter shall be referred to the Referee in charge and his decision shall be final.

*SITUATION 1 Rule 5.7 (d)*

*A player is on a breakaway with the opposing goaltender in his net and the buzzer sounds causing a stoppage of play. The buzzer sounding was due to a timekeeper error or mechanical failure. In the referee's judgment, there was enough time on the clock for the breakaway to have been completed.*

*Ruling:*

*A Penalty Shot is to be awarded.*



## SECTION 6 PHYSICAL FOULS

**Rule 6.1 Attempt to Injure or Deliberate Injury**

- (a) A Match penalty shall be assessed any player or team official who deliberately attempts to or deliberately injures an opponent, official, team official or spectator in any manner.
- (b) A Match penalty shall be assessed any player or team official who head-butts or attempts to head-butt an opponent with force or who injures an opponent with this action. A double Minor penalty shall be assessed any player who head-butts or attempts to head-butt an opponent but no injury results. A double Minor penalty and a Gross Misconduct shall be assessed any team official who head-butts or attempts to head-butt an opponent but no injury results.
- (c) A Match penalty shall be assessed to any player or team official that attempts to kick or deliberately kicks an opponent.
- (d) A player who pulls an opponent's hair or who grabs the facial protector, helmet, or chin strap of an opponent and uses this to gain an advantage or to inflict punishment or injury shall be assessed a Match penalty. A player who grabs an opponent's hair, facial protector, helmet or chin strap, but does not use it to gain an advantage or to inflict punishment or injury shall be assessed a Minor penalty or at the discretion of the referee a Major and a Game Misconduct penalty.
- (e) A Match penalty shall be assessed any player who uses her facial protector as a weapon.
- (f) A Match penalty shall be assessed any player who deliberately attempts to or deliberately injures an opponent with a slash, high stick, cross-check, **butt-end or spear**.

**SITUATION 1 Rule 6.1 (a)**

*Biting can definitely be classified as an attempt to injure. If injury results, it will be classified as a deliberate injury. In either case, a Match penalty shall be assessed any player or team official guilty of such action.*

**SITUATION 2 Rule 6.1 (a)**

*When a player strikes and injures a spectator, the Match penalty may apply, however, the Referee must be sure of the cause of the incident (see Situations 3 and 4). Any time a player is involved with a spectator, the incident must be reported to the President.*

**SITUATION 3 Rule 6.1 (a)**

*When a player becomes involved with a spectator, the Referee must be sure of the cause of the trouble. For example, if a spectator near the boards grabs, punches or holds a player and the player retaliates by swinging her stick or glove at the spectator, the player should not be penalized. She is really acting in self-defence. If the player did not cause the trouble, she should not be penalized for her actions, unless those actions become exaggerated and by no means justifiable in the eyes of the Referee. The Referee should have the spectator removed from that area and sent elsewhere in the stands or out of the arena altogether.*

**SITUATION 4 Rule 6.1 (a)**

*If a player, reacting to verbal harassment, goes into the stands to get at a spectator, the Referee must assess the player a Gross Misconduct, for making a travesty of the game. Should the player deliberately attempt to injure or deliberately injure that spectator, the Match penalty shall also apply.*

**SITUATION 5 Rules 6.1 (a)**

*Where a player and an opposing player or team official deliberately attempt to injure each other (eg. swinging stick incident), both participants shall be assessed a Match penalty. The Referee is required to write a detailed report to the President.*

**SITUATION 6 Rule 6.1 (d)**

*Grabbing the throat protector of an opponent is not specifically covered under Rule 6.1 (d), however, the interpretation should follow the same guidelines as the ones established for hair pulling, grabbing the facial protector, helmet, or chin strap of an opponent. A player who grabs the throat protector of an opponent, uses it to gain an advantage or to inflict punishment and/or injury, shall be assessed a Match penalty. A player who grabs the throat protector of an opponent, but does not use it to gain an advantage or to inflict punishment and/or injury, shall be assessed a Minor penalty.*

**SITUATION 7 Rule 8.1 & 7.2 (c)**

*Any "hooking" or restraining action using the shaft of the stick above the upper hand is penalized under Rule 7.2(c) – Hooking. "Butt-end hooking" is a type of hooking and is not considered a stick infraction for the purposes of Rule 4.2 (e) – Game Ejection.*

**SITUATION 8 Rule 6.1 (g)**

*The severity of the spearing action and/or the area of the body where the spear is directed should serve as guides to the type of penalty to assess (Match or double Minor). If the spearing action is directed at the groin, stomach, chest or head of an opposing player, a Match penalty would surely be warranted. If the spearing action is violent or vicious, a Match penalty shall be assessed, regardless of the area of the body where the spear is directed. If the player speared is injured as a result of that infraction, regardless of the area of the body involved, a Match penalty must be assessed to the player guilty of the spearing infraction. If the spearing action is directed at the leg or ankle area, or if the spear does not make contact, then a double Minor penalty may be assessed.*

**SITUATION 9 Rules 8.1**

*If the spearing or butt-ending is forceful, violent or vicious, or if injury results, a Match penalty must be assessed. The double Minor penalty is not to be used in lieu of the Match penalty, if the Match penalty is warranted. Referees should utilize the double Minor penalty for borderline spearing or butt-ending infractions which have previously gone unpenalized.*

**SITUATION 10 Rule 6.1 (b)**

*Examples of a double Minor penalty for head-butting could be:*

- a) Helmet to helmet contact, without the use of excessive force.*
- b) Helmet to facial protector contact, without the use of excessive force.*
- c) Facial protector to facial protector contact, without the use of excessive force. However, the severity of the contact is the determining factor to be considered by the Referee when deciding whether a double Minor penalty or a Match penalty is assessed.*

**Rule 6.2 Boarding and Body Checking**

- (a) A Minor penalty or, at the discretion of the Referee, a Major penalty and a Game Misconduct penalty, based upon the degree of violence of the impact with the boards, shall be assessed any player who body checks, cross-checks, elbows, charges or trips an opponent in such a manner that causes the opponent to be thrown violently into*

the boards. If a player is injured a Major penalty and a Game Misconduct penalty must be assessed.

- (b) In divisions of Atom and below and Female Hockey, a Minor penalty or, at the discretion of the Referee, a Major penalty and a Game Misconduct penalty shall be assessed any player who, in the opinion of the Referee, intentionally body checks, bumps, shoves or pushes any opposing player. If a player is injured, a Major penalty and a Game Misconduct penalty must be assessed.

When the offensive player is skating towards the defensive player, the defending player may not hit the offensive player by going in the opposite direction to that player. The body contact must be as a result of the movement of the offensive player. There must be no action where the offensive player is pushed, checked or shoved into the boards. Where, in the opinion of the Referee, accidental contact has taken place, no penalty shall be assessed.

#### SITUATION 1 Rule 6.2 (b)

*The situation of a player steering or directing an opposing player into the boards, without actually touching him, is acceptable. The most obvious example of this may be seen when a player is coming down the ice with the puck and he has to make a move or play on the defencemen. Quite often the puck carrier will try to go wide along the boards. In this case, we say that the defencemen has the right to close off the boards, in order to force the puck carrier to slow down or towards the middle of the ice. The principle that must prevail is that no player is entitled to use his body to intentionally body check, bump, push, or shove an opponent.*

### Rule 6.3 Charging

- (a) A Minor penalty or, at the discretion of the Referee, a Major penalty and a Game Misconduct penalty shall be assessed to any player who runs or jumps into or charges an opponent. If injury results, a Major penalty and a Game Misconduct penalty shall be assessed.

*Note: If more than two steps or strides are taken, it shall be considered a charge.*

- (b) A Major penalty and a Game Misconduct penalty shall be assessed any player who charges a goaltender while the goaltender is within his crease or who injures an opponent as a result of a charge.

*Note: A goaltender is not "fair game" just because he is outside the goal crease area. A penalty for interference (Minor or, at the discretion of the Referee, a Major penalty and a Game Misconduct penalty) or charging (Minor or, at the discretion of the Referee, Major penalty and a Game Misconduct penalty) shall be called where an opposing player makes unnecessary contact with a goaltender. Likewise, Referees should be alert to penalize goaltenders for tripping, slashing, or spearing in the vicinity of the goal.*

### Rule 6.4 Checking from Behind

- (a) A Minor penalty and a Game Misconduct penalty or a Major penalty and a Game Misconduct penalty at the discretion of the Referee, based on the degree of violence of the impact; shall be assessed any player who intentionally pushes, body checks, or hits an opposing player from behind, anywhere on the ice.

If a player is injured, a Major penalty and a Game Misconduct penalty must be assessed. A Match penalty could also be assessed under this rule.

- (b) Where a player is high sticked, cross-checked, body-checked, pushed, hit or propelled in any manner from behind into the boards or goal net, in such a way that the player is unable to protect or defend herself, a Match penalty shall be assessed.

*Note: Referees are instructed not to substitute other penalties when a player is checked from behind in any manner. This rule must be strictly enforced.*

#### CLARIFICATIONS

1. Checking from Behind entails that contact with the player being checked takes place in the back part of the body.
2. Where a player about to be checked turns and, as a result, creates contact with the back, a penalty shall be assessed to the player delivering the check for Checking from Behind.
3. The intent of this interpretation is not to penalize a player who comes up behind an opponent and in the process of playing the puck, makes unintentional contact with the back part of the body of the player being checked.
4. Riding off, pinching or rubbing a player shall be permitted as long as no intentional contact occurs to the back of that player, except as provided under Rule 6.2 (b) - Boarding and Body Checking, in divisions Atom and below and Female Hockey.
5. The determining factor for Checking from Behind versus Cross-Checking is whether or not the player applying the check is in motion. If the player is stationary and Cross-Checks an opponent from behind then a penalty for Cross-Checking should be assessed. If the player is in motion and Cross-Checks an opponent from behind, then a penalty for Checking from Behind shall be called. Notwithstanding the aforementioned, if a player is cross-checked from behind into the boards or the goal net, the Checking from Behind shall be called.

#### ADDITIONAL GUIDELINES TO ALL OFFICIALS

There are sufficient rules in the Hockey Canada Rule Book to cover most situations that may lead to spinal injuries. Referees should be aware of the tragic consequences of such injuries and strictly enforce the rules in situations such as the following:

1. Where a player along the boards, with her head down looking for the puck or “digging the puck out”, is hit from behind and driven head first into the boards with the head and neck in a flexed position.
2. Where a player in the process of checking an opponent swings the elbow and forearm out with the intent of throwing the opponent into the boards.
3. Where a player “kicks” or “pulls” an opponent’s feet out from behind and then pushes the player into the boards. Calling the penalty after the injury has occurred may be too late for that injured player. Only through Referees being consistent in calling this type of infraction with strict enforcement, will players and team officials realize the danger factor in committing such types of fouls. Everyone connected with the game is aware of the tragedy of a spinal injury with resulting paralysis. It is the responsibility of players, team officials and Referees to make every attempt possible to reduce the incident

of this frightful injury. Team officials can teach players legitimate methods of checking an opponent, while players can be educated to the dangers of checking an opponent illegally. The Referee has the responsibility to penalize players who illegally check an opponent. If the Referees are consistent and strict in calling infractions that may lead to spinal injuries, then hopefully, along with the cooperation of players and team officials, the chances of a player suffering such injuries can be significantly reduced.

**SITUATION 1 Rule 6.4 (a)**

**QUESTION:**

*The Referee has signaled a delayed Minor penalty for Checking from Behind on a player of Team "A". Team "B" scores before the play is stopped. Is the Game Misconduct still assessed to the offending player of Team "A"?*

**ANSWER:**

Yes.

**Rule 6.5 Checking to the Head**

- (a) A Minor and a Misconduct penalty, or a Major and a Game Misconduct penalty, at the discretion of the Referee based on the degree of violence of impact, shall be assessed to any player who checks an opponent to the head area in any manner.
- (b) A Major and a Game Misconduct penalty, or a Match penalty shall be assessed any player who injures an opponent by Checking to the Head.
- (c) A Match penalty shall be assessed any player who deliberately attempts to injure or deliberately injures an opponent by Checking to the Head.

*Note: Referees are instructed not to substitute other penalties when a player is Checked to the Head with significant impact.*

**CLARIFICATIONS ON CHECKING TO THE HEAD**

Referees should be aware of the tragic consequences of head injuries and concussions and strictly enforce the rule. It is the responsibility of players, team officials and Referees to make every attempt possible to reduce the incident of this frightful injury. Team officials can teach players legitimate methods of checking an opponent, while players can be educated to the dangers of checks to the head. The Referee has the responsibility to penalize players who check an opponent to the head. If the Referees are consistent and strict in calling infractions that may lead to concussions, then along with the cooperation of players and team officials, these type of fouls and the chances of a player suffering such injuries can be significantly reduced. The Checking to the Head penalty is based on the "degree of violence of impact" and can be defined in three categories: minimal, moderate and severe.

Minimal impact would be called under other appropriate rules. e.g. elbowing, highsticking, roughing, roughing after the whistle, etc. A glancing blow or minimal impact to the head where a penalty is warranted. Moderate impact would be a more significant degree of violence without injury that warrants a Minor and Misconduct penalty under Checking to the Head rule. Severe impact would be a high degree of violence, with or without injury, that warrants a Major and Game Misconduct or a Match penalty, at the discretion of the Referee under the Checking to the Head rule. What previously may have been considered a legal check with a shoulder check to the head shall now be penalized as Checking to the Head if moderate or severe impact is made. These Checking to the Head infractions can occur anywhere on the

playing surface as a result of the initial contact to the Head. Checking to the Head could also be the result of an open ice hit, with or without the fouled player's head being down. Body checking has not been removed from the game, but high hits or targeting the head shall be penalized. A fight is still to be called a Fight, not Checking to the Head. Referees are to strictly enforce penalties that call for infractions as a result of low hits as these types of infractions may increase. The penalty signal for "Checking to the Head" will be patting flat (open palm) of the non-whistle hand on the side of the head.

#### SITUATION 1

##### QUESTION:

*The Referee has signaled a delayed Minor penalty for Checking to the Head on a player from Team "A". Team "B" scores before the play is stopped. Is the misconduct penalty still assessed to the offending player of Team "A"?*

##### ANSWER:

Yes.

#### SITUATION 2

*The referee is to use the following guidelines for goaltender infractions in the use of blocker infractions on opponent.*

- *Pushing a player away may result in a penalty*
- *Hitting a player with the blocker in a punching motion may result in a penalty for roughing*
- *Hitting a player with the blocker in the head area would result in a Minor + Misconduct as per Rule 6.5 "Checking to the Head"*
- *If injury occurs then a Major + Game Misconduct would be assessed under Rule 6.7 (f) Fighting and Roughing or Rule 6.5 - Checking to the Head*
- *For very serious and violent attacks a Match penalty may be assessed under Rule 6.1 - Attempt to injure.*

### Rule 6.6 Elbowing and Kneeing

- (a) A Minor penalty or, at the discretion of the Referee, a Major penalty and a Game Misconduct penalty shall be assessed any player who fouls an opponent in any manner with his elbow or knee.
- (b) A Major penalty and a Game Misconduct penalty shall be assessed any player who injures an opponent by elbowing or kneeling.

### Rule 6.7 Fighting and Roughing

- (a) A Major penalty and a Game Misconduct penalty shall be assessed any player that fights **with an opposing player**.
- (b) A player who is identified by the Referee as being the instigator, or the aggressor in a fight shall be assessed a Minor penalty, in addition to any other penalties she may incur.

**NEW** (1) **A Minor penalty for instigator shall be assessed any player identified by the Referee as being the instigator of a fight.**

**NEW****(2) A Minor penalty for aggressor shall be assessed any player identified by the Referee as being the aggressor in a fight.**

- (c) A Minor penalty shall be assessed any player who, having been struck, shall retaliate with a blow or attempted blow. Should such a player continue to retaliate, she shall be assessed a Major penalty and a Game Misconduct penalty.
- (d) Any player who does not retaliate after being struck will not be assessed a penalty under this section, but may be assessed a penalty for a violation of other rules.
- (e) Any player wearing a ring or rings, tape or any other material on her hands, who becomes involved in a fight and who uses such to gain an advantage or to inflict punishment and/or injury, shall be assessed a Match penalty in addition to any other penalties she may incur.
- (f) When a fight occurs, all other players except the goaltender shall immediately retire to the front of their respective benches or to a neutral zone (should the fight occur in front of a players' bench) designated by the Referee and remain there until the Referee calls them back to resume play. The goaltenders must stay in their goal creases or proceed to a neutral zone designated by the Referee. Any player(s) refusing to do so after being instructed by the Referee shall be assessed a Misconduct penalty, plus any other penalty she (they) may incur.
- (g) A Major penalty and a Game Misconduct penalty shall be assessed any player who is involved in fighting with another player off the playing surface.
- (h) Any player joining in a fight, acting as a peacemaker or taking part in another fight during the same stoppage of play, will be assessed a Game Misconduct penalty plus any other penalty the offender incurs under the rules.
- (i) Any player or team official who becomes involved in a fight with a team official shall be assessed a Gross Misconduct penalty. This does not eliminate the possibility of further penalties being assessed for such an infraction.
- (j) Branches are authorized, at the discretion of their members, to assess further penalties in the case of Rule 6.7 (a), for all players in all divisions of hockey.
- (k) A Minor penalty or, at the discretion of the Referee, a Major penalty and a Game Misconduct penalty shall be assessed to any player who is guilty of unnecessary rough play.

*Note 1: If the penalty assessed is for an infraction after the whistle, "Roughing after the Whistle" shall be recorded.*

*Note 2: The Major penalty for roughing is not to be confused with and utilized in lieu of the Major Penalty and a Game Misconduct Penalty for fighting.*

- (l) A Minor penalty or, at the discretion of the Referee, a Major and a Game Misconduct penalty shall be assessed any player who, in the Referee's judgment, makes deliberate physical contact with an opponent after the whistle.

**SITUATION 1 Rule 6.7 (l)**

*It is the opinion of the Hockey Canada Board of Directors that too much contact is being made by players after the Referee or Linesmen have blown their whistle to stop play. The intent of this rule is to strictly penalize players who fail to obey the whistle. This unnecessary contact can be with the body or the stick. Officials are directed to strongly enforce this section with the appropriate penalty.*

## SITUATION 2

## QUESTION:

At a stoppage of play, a Team "A" player pushes a Team "B" player who then pushes back. What is the proper procedure for the Referee?

## ANSWER:

The Referee would assess the Team "A" player a Minor penalty for "Roughing after the Whistle". Where the retaliation is too severe to be ignored and that player is penalized, then the Referee is encouraged to assess the initial player a double Minor penalty so that a time differential exists. Note: The key is to penalize the team which causes the initial foul.

## SITUATION 3 Rule 6.7 (a)(h)

Anytime a Major penalty and Game Misconduct have been assessed for fighting, whether or not both players receive Majors and Game Misconduct's, it has to be classified as a fight. Therefore, the third player to enter must receive the automatic Game Misconduct.

## SITUATION 4 Rule 6.7 (a)(h)

One player receives a Minor penalty for slashing and a second player receives a Major and Game Misconduct for fighting. A third player enters the fight.

## RULING:

The player assessed the Major and the Game Misconduct would automatically receive a Minor penalty for being an aggressor. Officials are to assess the additional Minor as the aggressor, in situations where only one player is assessed a Major penalty for fighting. The third player receives a Game Misconduct for entering the fight, plus whatever other penalties she may incur.

## SITUATION 5 Rule 6.7 (h)

The third player (and all subsequent players) to enter a fight or a player who acts as a peacemaker applies only to situations where at least one player has been assessed a fighting penalty.

## SITUATION 6 Rule 6.7 (g)(i)

## QUESTION:

What is the penalty for a player on the ice becoming involved with:

- (a) A player on the bench?
- (b) A coach on the bench?

## ANSWER:

- (a) Where a player on the ice becomes involved in a fight with a player off the ice, assess a Major penalty for fighting and a Game Misconduct to both participants.
- (b) Where a player who is on the ice surface becomes involved in a fight with a team official who is off the ice, assess a Gross Misconduct to both participants, for making a travesty of the game. No instigator or aggressor penalty may be assessed in this situation. See Rule 6.7, Situation 18 and Rule 7.3 (c)(d).

## SITUATION 7 Rule 6.7 (g)(h)

During a fight on the ice, a player on the ice becomes involved in another fight with a player of the opposing team who is on the bench.

## RULING:

Assess both players (the one on the ice and the player on the bench) Majors and Game Misconduct's, under Rule 6.7 (g) - for fighting off the playing surface. Both players would



also receive an additional Game Misconduct, under Rule 6.7 (h) - for taking part in another fight during the same stoppage of play.

*Note: When a situation arises that warrants the assessment of multiple Game Misconduct's to a player, assess and record each one on the Official Game Report but have only one Game Misconduct per player announced on the P.A. system.*

#### SITUATION 8

*A player involved in the original fight that causes a stoppage of play, leaves that fight and starts another fight with a different player of the opposing team. What penalties is she assessed ?*

##### **RULING:**

*The player involved in the two fights would get an instigator Minor for starting the second fight, two Major penalties and three Game Misconduct's. Two of the Game Misconduct's are related to the Majors for fighting. The third Game Misconduct is for taking part in another fight during the same stoppage of play. Rule 6.7 (h).*

#### SITUATION 9 Rule 6.7 (h)

*If two players are fighting on the ice, close to the players' bench and one of the players on the bench intervenes as a peacemaker in the fight while still on the bench, that player shall be assessed a Bench Minor plus a Game Misconduct for Interference - Rule 7.3 (d), plus an additional Game Misconduct - Rule 6.7 (h) and any other penalties she may incur. This player is to be classified as the third player to enter a fight. If, on the other hand, a team official intervenes as a peacemaker in the fight, that team official shall be assessed a Bench Minor plus a Game Misconduct for Interference - Rule 7.3 (d). A team official can not be assessed a Game Misconduct under Rule 6.7 (h).*

#### SITUATION 10 Rule 6.7 (f)

*There must be a fight to apply this rule. Referees must direct the players to their respective players' bench unless the fight is in front of the bench.*

#### SITUATION 11 Rule 6.7 (f)

*Where a fight occurs on the ice, it is imperative that the Referee warn the remaining players to go to their respective benches. Referees are encouraged to use their whistle, voice and physical gestures to send the players back. Misconduct's for violations of this rule must not be assessed until the Referee has first issued the warning to the players.*

#### SITUATION 12

##### **QUESTION:**

*If a fight occurs in the immediate vicinity of the goal crease, would the goaltender be allowed to go to her own players' bench?*

##### **ANSWER:**

*With the permission of the Referee, the goaltender may proceed to her own bench. If she does so on her own accord, she is to be assessed a Minor penalty for leaving her crease during a fight.*

#### SITUATION 13 Rule 6.7 (b)

##### **QUESTION:**

*Could a player be assessed two instigator and/or two aggressor penalties if she is involved in two fights during the same stoppage of play?*

##### **ANSWER:**

*Yes.*

**SITUATION 14 Rule 6.7 (b)**

*It is possible under the rules for a player to be assessed a Minor penalty for being the instigator and another Minor penalty for being the aggressor in the same fight.*

**SITUATION 15 Rule 6.7 (g)**

*A player on the ice and a player on the bench become involved in a fight. The player on the bench is clearly the instigator.*

**RULING:**

*Both players would be assessed Majors and Game Misconduct penalties as covered under Rule 6.7 (g). However, since the player on the bench is identified as the instigator, she should be assessed an additional Minor penalty, under Section 6.7 (b). Note: Rule 6.7 (b) of this rule may be applied regardless of the location of the fight.*

**SITUATION 16**

*A fight occurs in the game and, in a short period of time, all 10 players on the ice and the goaltenders become involved in fights. No player from either team leaves their bench.*

**RULING:**

*The Referee should assess all 10 players plus the two goaltenders Major penalties for fighting plus the appropriate Game Misconduct's. Note: The maximum number of 5 players per team assessed Game Misconduct's would not apply as no players left the bench. In order to apply this Rule 9.5 (c) Note 1, at least one player must have left the bench. Since no player left the bench the maximum 5 Game Misconduct penalties cannot be applied. As a result, all players on the ice including the goaltenders are assessed Game Misconduct penalties.*

**SITUATION 17**

*At no time may a Major penalty be assessed to a player for fighting with a spectator. The player will either be assessed a Gross Misconduct, a Match penalty or nothing at all, depending on the circumstances. See Rule 6.1, Situations 3, 4 and 5.*

**SITUATION 18 Rules 6.7 (i) and 7.3 (d)**

*Where a team official on the bench interferes with an opposing player on the ice and in the ensuing moment both the player and the team official get into a fight, the Referee should assess the penalties as follows:*

- *The player would be assessed a Gross Misconduct, under Rule 6.7 (i), for fighting with a team official.*
- *The team official would be assessed a Bench Minor and Game Misconduct, under Rule 7.3 (d), for interference from the players' bench, as well as a Gross Misconduct, under Rule 6.7 (i), for fighting with a player.*

**SITUATION 19 Rule 6.7 (k)**

*Any contact with the gloves in the face or head area constitutes roughing and must be called. This type of violation happens when one player is checking the puck carrier or around the net and especially after the whistle. This type of foul must be strictly enforced and penalties assessed.*

**SITUATION 20 Rule 6.7 (a)**

*There has been a great deal of concern and criticism regarding fighting and roughing (where players are assessed fighting penalties and Game Misconduct). Much of the criticism is due to the fact that the Referees are not applying the rule in the manner that was intended. Where two players are "slugging it out toe to toe" or wrestling on the ice (each equally*

*involved) resulting in the fact that both players are ejected from the game with the appropriate penalties, is not a point of concern. The situation of major concern to players, coaches and management relates to the incidents where one player makes no attempt to retaliate other than to protect herself. Yet, both players end up being ejected from the game. Another such situation is where one player "simply covers up" to prevent being pummeled, yet both players are ejected from the game or both players are assessed Minors or double Minors for roughing, yet one player did all the punching. On the subject of double Minors, a number of officials assess double Minors for roughing to avoid the Major penalty and the Game Misconduct for fighting. This is not the intent of the rule. Referees have been constantly informed not to call double Minors for roughing. It is either a Minor for roughing or a Major and a Game Misconduct for fighting. Where a number of punches have been thrown and/or the officials have difficulty separating the two players, then a Major and a Game Misconduct shall be assessed. The rules specifically state that one player may be assessed a Major plus a Game Misconduct for fighting and the opposing player a Minor for roughing or perhaps not assessed any penalty, in this case the player receiving the Major penalty would also receive an extra Minor penalty as aggressor. Hockey Canada is attempting to make the job of the Referee somewhat easier and gain them more respect but at the same time a Referee must have the "fortitude" to call the game by the rules and not take the easy way out. A Referee must not attempt to make himself appear to be the "good guy" and try to satisfy both teams - this will not work out, for he will only end up with more problems. Call the rules as intended and there will be far less criticism of the rules and the Referees.*

#### SITUATION 21

*In a situation where two willing combatants each drop their gloves and square off to fight, the player of Team "A" knocks the player of Team "B" down with the first punch.*

#### **RULING:**

*Assess each player 5 minutes for fighting plus a Game Misconduct. There is no instigator nor aggressor penalty assessed, as both players were willing combatants.*

*Note: This is only applied where both combatants are willing to fight. In a situation where a player is blindsided or sucker punched, only the aggressor will be assessed a Major and Game Misconduct for fighting, and a Minor penalty for aggressor.*

## SECTION 7 RESTRAINING FOULS

### Rule 7.1. Holding

- (a) A Minor penalty or, at the discretion of the Referee, a Major penalty and a Game Misconduct penalty shall be assessed any player who holds an opponent with her hands, stick or in any other manner. If the penalty assessed is for holding the stick, a Minor penalty for "holding the stick" shall be recorded and announced.
- (b) A Major penalty and a Game Misconduct penalty shall be assessed any player who injures an opponent by "holding".

### Rule 7.2 Hooking

- (a) A Minor penalty or, at the discretion of the Referee, a Major penalty and a Game Misconduct penalty shall be assessed to any player who impedes or seeks to impede the progress of an opponent by "hooking" or "butt-end hooking" with his stick.
- (b) A Major penalty and a Game Misconduct penalty shall be assessed any player who injures an opponent by "hooking" or "butt-end hooking".

### Rule 7.3 Interference/Protection of the Goaltender

- (a) A Minor penalty for interference or, at the discretion of the Referee, a Major penalty and a Game Misconduct penalty shall be assessed any player who:
  - (1) interferes with or impedes the progress of an opponent who is not in possession of the puck, or
  - (2) deliberately knocks a stick out of an opponent's hand, or
  - (3) prevents an opponent who has lost or dropped his stick from regaining possession of it.

*Note 1: The last player to touch the puck - other than the goaltender - shall be considered the player in possession.*

*Note 2: Often the action and movement of the attacking player causes the interference, since the defending players are entitled to "stand their ground" or "shadow" the attacking players. Players of the side in possession of the puck shall not be allowed to "run" deliberate interference for the puck carrier.*

- (b) A Minor penalty for interference with the goaltender shall be imposed on a player who, by means of his stick or his body, interferes with or impedes the movements of the goaltender by actual physical contact. The penalty should be announced as "Interference with the goaltender".

*Note: A goaltender is not "fair game" just because he is outside the goal crease. A penalty for interference (Minor or, at the discretion of the Referee, a Major penalty and a Game Misconduct penalty) or charging (Minor or, at the discretion of the Referee, Major penalty and a Game Misconduct penalty) shall be called where an opposing player makes unnecessary contact with the goaltender. Likewise, Referees should be alert to penalize goaltenders for tripping, slashing, or spearing in the vicinity of the goal.*

*Unless the puck is in the goal crease area, a player of the attacking side may not stand in the goal crease. If the puck should enter the net while such conditions prevail*

*the goal shall not be allowed. If an attacking player has physically interfered with the goaltender, prior to or during the scoring of the goal, the goal will be disallowed and a penalty for "interference with the goaltender" will be assessed and announced.*

*The ensuing face-off shall be taken in the neutral zone, at the face-off spot nearest the attacking zone of the offending team.*

*If a player of the attacking team has been physically interfered with by the actions of any defending player so as to cause him to be in the goal crease and the puck should enter the net while the player so interfered with is still in the goal crease, the goal shall be allowed.*

*A Minor penalty shall be assessed to an attacking player, who while his team has possession of the puck, is interfered with by a defending player, but fails to attempt to avoid making contact with the goaltender. In addition, if a goal is scored it shall be disallowed.*

*A Minor penalty shall be imposed on an attacking player, not in possession of the puck, who is tripped or caused to fall and fails to attempt to avoid contact with the goaltender whether he is in or out of his crease.*

*A Minor penalty shall be imposed on any attacking player, who makes deliberate contact with a goaltender whether in or out of the goal crease.*

*At the discretion of the Referee a Major penalty and a Game Misconduct penalty may be imposed under Rule 6.3 (b) - Charging or Rule 8.2 (c) - Cross-checking. In the event that a goaltender has been pushed into the net together with the puck after making a stop, the goal will be disallowed. If applicable, the appropriate penalties will be assessed.*

- (c) *Where a stick or any object is thrown on the ice from the players' or penalty bench or where a player on the ice is interfered with by an opposing player or team official on the players' or penalty bench, (whether or not play is in progress), a Bench Minor penalty shall be assessed to that team if the Referee is unable to identify the person responsible, except as covered in Rule 4.10 (a)(4) - Awarded Goals and Rule 7.4 (d) - Tripping. If a goal is scored, no Bench Minor penalty would be assessed.*
- (d) *Where a stick or any object is thrown on the ice from the players' or penalty bench or where a player on the ice is interfered with by an opposing player or team official on the players' or penalty bench (whether or not play is in progress) and the Referee is able to identify the person responsible; that person shall be assessed a Bench Minor penalty and a Game Misconduct penalty. When Rule 4.10 (a)(4) - Awarded Goals or Rule 7.4 (d) - Tripping are applied, the Bench Minor penalty would not apply but the Game Misconduct penalty would.*
- (e) *A Major penalty and a Game Misconduct penalty shall be assessed any player who injures an opponent by "interference".*
- (f) *A Minor penalty for interference shall be assessed to a goaltender that deliberately piles snow inside his goal crease at any time or is observed by the Referee to have deliberately left or placed an object in his defending zone at or near the net before proceeding to the player's bench.*

*A Penalty Shot shall be awarded to the non-offending team if, in the Referee's opinion, such object or obstacle actually prevents a goal while the offending team's goaltender is legally on the ice. If a Penalty Shot is awarded under this rule, the Minor penalty shall not be assessed.*

A goal shall be awarded if, in the opinion of the Referee, such object or obstacle actually prevents a goal after the offending goaltender has been legally substituted by another player.

**SITUATION 1****QUESTION:**

*A player of the attacking team enters the opponent's goal crease illegally with the puck in the attacking zone. The defending goaltender slashes him. The Referee signals a delayed penalty on the goaltender and subsequently the attacking team scores a goal while the delayed penalty is still on and the player is still in the crease. Is the goal allowed? Is the penalty to the goaltender assessed?*

**ANSWER:**

*The goal is not allowed and a Minor penalty is assessed to the goaltender.*

**SITUATION 2****QUESTION:**

*Team "A" shoots the puck from behind the centre red line so as to constitute a possible icing call. A player of Team "A" who is on-side and eligible to play the puck, attempts to do so in the opposing team's end, before icing occurs. The goaltender of Team "B" shoots a portion of a broken stick so as to interfere with the puck. What penalty is assessed?*

**ANSWER:**

*Allow play to be completed. Assess the goaltender a Minor penalty for interference.*

**SITUATION 3 Rule 7.3 (a)(1)**

*Where a player with a stick in his hands shoots a broken stick or any other object on the ice at an opposing player and hits the opponent or interferes with his progress, whether or not he has the puck, assess a Minor penalty for interference. If the opposing player is injured by the broken stick, assess the guilty player a Major and Game Misconduct for Interference. A Match penalty may be assessed if, in the opinion of the Referee, there was either deliberate attempt to injure or deliberate injury.*

**SITUATION 4**

*Where a player is on a breakaway in the neutral or attacking zone, and a stick or other object on the ice is shot at him by an opposing player preventing him from getting a clear and unimpeded shot on the goal, then award a Penalty Shot under Rule 7.4 (d). Classify this as being fouled from behind and being prevented from having a clear shot on goal. If the player is able to get a clear shot on goal, only a Minor penalty for Interference would be assessed.*

**SITUATION 5 Rule 7.3 (d)****QUESTION:**

*Would a penalty be assessed if a Team Doctor, who is identified as one of the five team officials occupying the player's bench, throws an object on the ice?*

**ANSWER:**

*Yes. A Bench Minor penalty plus a Game Misconduct would be assessed.*

**SITUATION 6 Rule 7.3 (b)**

*The key to understanding this rule is to realize that the onus is on the attacking player to avoid contact with the goaltender.*

**SITUATION 7 Rule 7.3 (f)**

*A team pulls its goaltender for an extra player. Before leaving her crease, the goaltender*

places her stick across the front of the goal, meanwhile her team scores a goal. The Referee, upon looking back to the other end of the rink, observes the stick across the front of the goal.

**RULING:**

Wash out the goal and assess the goaltender a Minor penalty for Interference.

**SITUATION 8 Rule 7.3 (f)**

As the goaltender leaves the ice to be replaced by another player, she drops or places her stick in front of the net.

**RULING:**

It is the responsibility of the goaltender to keep the area near her net free of any obstacles that may prevent a goal from being scored. For an infraction of this rule, whether or not the action is observed by the Referee, a Minor penalty shall be assessed. If when the goaltender has been removed, the puck is prevented from entering the goal due to the stick, the Referee shall award a goal. Note 1: Use the goal crease as the guideline for this situation and any part of the stick in contact with any part of the goal crease would constitute an Interference infraction. Note 2: If a player (as opposed to a goaltender) puts a stick in the crease with the goaltender off the ice, assess an Unsportsmanlike Conduct penalty under Rule 9.2 (a). If such action prevents the scoring of a goal, award a Goal under Rule 4.10 (b).

**SITUATION 9 Rule 7.3 (f)**

Where the goaltender, who is leaving the ice, drops or places her stick on the ice a considerable distance out from the goal crease, NO penalty may be assessed if the action was not observed by the Referee. If the action was observed by the Referee then a Minor penalty for Interference shall be assessed. However, when the goaltender has been removed, if the puck is prevented from entering the goal because of the stick then the Referee shall award a Goal.

**SITUATION 10 Rule 7.3 (f)**

A goaltender in her crease has piled snow near the goal posts and goal line. The opposing team shoots the puck which in the opinion of the Referee is prevented from entering the goal by the piled snow. What is the correct ruling?

**RULING:**

Assess the goaltender a Minor penalty for Interference. In this case a goal may not be awarded with the goaltender still on the ice.

**Rule 7.4 Tripping**

- (a) A Minor penalty or, at the discretion of the Referee, a Major penalty and a Game Misconduct penalty shall be assessed any player who trips an opponent. If injury results, a Major penalty and a Game Misconduct penalty shall be assessed.

*Note: A penalty shall not be assessed if, in the Referee's opinion, a player is unquestionably hook-checking the puck and obtains possession of it, thereby tripping the puck carrier.*

- (b) A Minor penalty or, at the discretion of the Referee, a Major penalty and a Game Misconduct penalty shall be assessed any player who uses his feet to knock an opponents skates out from under him with a kicking or leg dragging motion from behind ("slew footing").

*Note: If a player in the process of falling or sliding along the ice, hits or knocks the puck from her opponent's stick prior to making actual body contact, the tripping shall be ignored.*

- (c) Where a player uses her stick, knee, hand, foot, arm or elbow in any manner or falls or slides along the ice directly in the path of the puck, causing the puck carrier to trip and lose possession of the puck, a penalty shall be assessed.

*Note: If a player in the process of falling or sliding along the ice, hits or knocks the puck from her opponent's stick prior to making actual body contact, the tripping action shall be ignored.*

- (d) When a player in control of the puck on a breakaway in the neutral or attacking zone is tripped or otherwise fouled from behind and thus prevented from having a clear shot on goal, having no other opponent to pass other than the goaltender, a Penalty Shot shall be awarded to the non-offending team. Nevertheless, the Referee shall not stop play until the attacking team has lost control of the puck to the defending team.

*Note: "Control of the puck" shall be defined as the act of propelling the puck with the stick, the skate(s) or the glove(s).*

*If, while it is being propelled, the puck shall touch the person, stick or skate of another player or should hit the goal post or go free, the player shall be deemed no longer in control. The intention of this rule is to restore a good scoring opportunity which has been lost by reason of the foul, and therefore, where there is no reasonable scoring chance lost by reason of the foul, a Penalty Shot should not be awarded.*

#### SITUATION 1 Rule 7.4 (d)

##### CLARIFICATION:

*The words "otherwise fouled" shall include throwing a stick or any other object at the puck or puck carrier, or again shooting any object at the puck or puck carrier or a player without a helmet chasing a player on a breakaway in the neutral or attacking zone.*

#### SITUATION 2

##### QUESTION:

*A player has a breakaway in the neutral or attacking zone and is fouled from behind. She then gets up and takes a clear unimpeded shot on goal. Should a Penalty Shot be awarded if the goal is not scored ?*

##### ANSWER:

*No.*

#### SITUATION 3 Rule 7.4 (a)(b)

*The tripping rule is also to be used to penalize any act of taking out an opponent's feet, such as slew footing, submarining, or diving at an opponent's feet which results in the player being knocked off his feet.*



## SECTION 8 STICK FOULS

### Rule 8.1 Butt-Ending

**NEW** A Match penalty shall be assessed any player or team official who deliberately butt-ends or deliberately attempts to butt-end an opponent by jabbing her forcefully with the butt-end of the stick, or who injures an opponent by any butt-ending action. At the discretion of the Referee, a double Minor penalty shall be assessed to any player who attempts to butt-end an opponent with the butt-end of her stick. A double Minor penalty and a Gross Misconduct shall be assessed to any team official who attempts to butt-end an opponent with the butt-end of her stick.

### Rule 8.2 Cross-Checking

- NEW**
- (a) A Minor penalty or, at the discretion of the Referee, a Major penalty and a Game Misconduct penalty shall be assessed any player who cross-checks an opponent.
  - (b) Any player who strikes an opponent above the normal height of his shoulders with a cross-check shall incur a Major penalty and a Game Misconduct penalty, whether or not injury results.
  - (c) A Major penalty and a Game Misconduct penalty shall be assessed any player who cross-checks a goaltender while he is in his crease.
  - (d) A Major penalty and a Game Misconduct penalty shall be assessed any player who injures an opponent as a result of a cross-check.
  - (e) A Match penalty shall be assessed any player who deliberately injures an opponent with a cross-check.

#### SITUATION 1

*If during the cross-checking action, a player contacts an opponent with his stick, then that is cross-checking. However, if under the same type of action, the player contacts the opposing player with his fists or gloves, then this action should be classified as roughing and the appropriate penalties assessed.*

### Rule 8.3 High Sticks

- NEW**
- (a) The carrying of sticks above the normal height of the shoulder of the opponent is prohibited. A Minor penalty or, at the discretion of the Referee, a Major penalty and a Game Misconduct penalty shall be assessed any player who checks or intimidates an opponent while carrying his stick above the shoulder of his opponent. If injury results, a Major penalty and a Game Misconduct penalty shall be assessed.
  - (b) A player who contacts an opponent above the normal height of his shoulders with a high stick shall be assessed a Minor penalty or, at the discretion of the Referee, a Major penalty and a Game Misconduct penalty. If injury results, a Major penalty and a Game Misconduct penalty shall be assessed. In Junior and Senior hockey, at the discretion of the Referee, should the injury be caused by an accidental high stick, a double Minor penalty may be assessed.
  - (c) A Match penalty shall be assessed any player who deliberately attempts to injure or deliberately injures an opponent with a high stick.
  - (d) Contacting the puck above the normal height of the shoulders with the stick is prohib-

ited and when it occurs, play shall be stopped and the ensuing face-off shall be at the spot where the offense occurred, unless:

- (1) a player of the non-offending team obtains possession and control of the puck, in which case play shall continue,
  - (2) a player of the offending side shall bat the puck into his own goal, in which case the goal shall be allowed,
  - (3) the offending team gains a territorial advantage, then the face-off shall be where the stoppage of play occurred, unless otherwise stated in the rules
- (e) A goal scored from a high stick shall not be allowed, except when such a goal is scored by a player of the defending team into his own goal.

**SITUATION 1 Rule 8.3 (a)**

*Where a player raises his stick in an attempt to intimidate an opponent or delay his progress because of the high stick, assess a Minor penalty for high sticking, even though no contact is made with the opposing player.*

**SITUATION 2 Rule 8.3 (a)**

*Where a player high sticks the puck and then on the follow through, hits an opposing player above the shoulder, and no injury has resulted, assess a Minor penalty for high sticking.*

*This interpretation would also apply on a follow through of shooting the puck.*

*NOTE: The player is responsible for their stick at all times.*

**SITUATION 3 Rule 8.3 (d)**

**QUESTION:**

*A defending player high sticks the puck in his defending zone and the puck deflects to his own goaltender or to a teammate. When is play stopped?*

**ANSWER:**

*When the goaltender or teammate gains control of the puck.*

**SITUATION 4 Rule 8.3 (d)(1)**

*A goaltender high sticks the puck. The puck drops in the goal crease and an opposing player shoots the puck into the goal.*

**RULING:**

*Goal.*

**SITUATION 5 Rule 8.3 (d)**

*A player has his stick above the normal height of his shoulders. The puck, however, hits the butt-end of the stick below the level of the shoulders and goes into the goal.*

**RULING:**

*Goal.*

**SITUATION 6 Rule 8.3 (d) and Rule 10.10 (a) Situation 1**

*Where a player or goaltender contacts the puck with a high stick, the Referee will delay the call. If it becomes obvious that both teams are refraining from playing the puck, the Referee should stop play immediately. The ensuing face-off would occur at the place where the stoppage of play occurred, unless otherwise stated in the rules.*

**RATIONALE:**

*Rule 10.2 (f) is invoked because both teams have committed an infraction of the rules - one team contacted the puck with a high stick; the other, by not pursuing possession and control, has failed to keep the puck in motion.*

**SITUATION 7 Rule 8.3 (d)**

*Where an attacking player in the attacking zone contacts the puck with a high stick and the defending team refrains from playing the puck, stop play and conduct the face-off at one of the end zone face-off spots of the team refusing to play the puck (in accordance with Rule 10.10 (a)) where the puck was located when play was stopped.*

**SITUATION 8 Rule 8.3 (d)**

*Where a puck contacted with a high stick, deflects off an opposing player and is taken by a player of the offending team, play shall be stopped. A deflection is not possession and control.*

**SITUATION 9 Rule 8.3 (d)(e)**

*Where a puck is contacted with a high stick, then deflects off an opposing player into the goal of that team, the goal shall not count. Again deflection is not possession and control.*

**SITUATION 10**

*A player of Team "A" contacts the puck with a high stick and while the puck is still in the air, a player of Team "B" contacts the puck with a high stick.*

**RULING:**

*Immediate stoppage of play, with the face-off at the point where the second infraction occurred, unless otherwise covered in the rules. If the player of Team "B" was an attacking player in the attacking zone, the face-off shall take place in the neutral zone. No goal may be scored in this situation.*

**SITUATION 11**

*Defending Team "B" in its defending zone attempts to ice the puck. An attacking player of Team "A" in the attacking zone deflects the puck with a high stick, the puck then continues down over the goal line and Team "A" refrains from playing the puck which is now in their defending zone.*

**RULING:**

*Stop play when it has become obvious that Team "A" is refraining from playing the puck. The face-off shall take place at the nearest end zone face-off spot, as per Rules 10.2 (f) and 10.10 (a).*

**SITUATION 12 Rule 8.3 (b)**

*In Junior and Senior Hockey, where a double Minor can be assessed for an injury for an accidental high stick, officials are to ensure that this penalty is only assessed for minor contact. In no way should this call be substituted for actions which warrant a Major and Game Misconduct. The following attempted restraining fouls shall be deemed accidental high sticks:*

- *When a hooking action, whereby the stick accidentally slides up from the upper body to the neck or head area, causing injury, a double Minor shall be assessed.*
- *When attempted lifting of the opponents stick, which results in accidental contact to the neck or head area, causing injury, a double Minor shall be assessed.*
- *When a player, while losing his balance and/or falling, accidentally clips an opponent with his stick in the neck or head area, causing injury, a double Minor shall be assessed.*

The following acts shall be considered “negligent” use of the stick, and a Major and Game Misconduct shall be assessed where injury results.

- When a slash, glancing off the upper body that deflects upwards to the neck or head area, causing injury, a Major and Game Misconduct shall be assessed.
- When a cross check, glancing off the upper body that deflects upwards to the neck or head area, causing injury, a Major and Game Misconduct shall be assessed. Although restraining fouls with the stick would normally be perceived to be accidental in nature, any aggressive, reckless, negligent or forceful action of the stick (e.g. pitchfork action in lifting stick or hooking an opponent) that results in contact to the neck or head area, causing injury, shall result in a Major and Game Misconduct being assessed.

#### SITUATION 13 Rule 8.3 (b)

##### Question:

A player from Team A in the attacking zone is hit in the face with a high stick causing injury that is not observed by the referee.

Immediately following, a player on Team B is sent on a breakaway and is tripped from behind and the referee signals a penalty shot. As this is the first stoppage of play, the linesman reports the high stick with injury to the referee.

##### Ruling:

Assess the Major plus Game Misconduct penalty for the high stick to the player from Team B and a minor penalty for tripping to Team A. This would nullify the Penalty Shot.

### Rule 8.4 Slashing

- NEW**
- (a) A Minor penalty or, at the discretion of the Referee, a Major penalty and a Game Misconduct penalty shall be assessed any player who impedes or seeks to impede the progress of an opponent by “slashing” with her stick.
  - (b) A Major penalty and a Game Misconduct penalty will be assessed to any player who injures an opponent with a “slash”.
  - (c) A “slashing” penalty shall be assessed any player who swings her stick at an opponent (whether out of range or not) without actually striking her, or who, on the pretext of playing the puck, makes a wild swing at the puck with the object of intimidating her opponent.
  - (d) A Match penalty shall be assessed any player who deliberately attempts to injure or deliberately injures an opponent with a slash.

### Rule 8.5 Spearing

- NEW** A Match penalty shall be assessed any player or team official who deliberately spears or deliberately attempts to spear an opponent by jabbing her forcefully with the toe of the blade of the stick, or who injures an opponent by any spearing action.

A double Minor penalty shall be assessed any player who pokes or jabs or attempts to jab an opposing player with the toe of the blade of the stick. A double Minor penalty and a Gross Misconduct shall be assessed any team official who pokes or jabs or attempts to jab an opposing player with the toe of the blade of the stick.

## SECTION 9 OTHER FOULS

### Rule 9.1 Handling the Puck

- (a) Play shall immediately be stopped and a Minor penalty shall be assessed any player except a goaltender who closes her hand on the puck and, while so doing, gains an advantage on her opponents. When a player simply closes her hand on the puck and immediately drops it to the ice, without gaining or attempting to gain an advantage by this action, play shall be allowed to continue.
- (b) A Minor penalty shall be assessed a goaltender who deliberately holds the puck and in the opinion of the Referee, is causing an unnecessary stoppage in play.
- Note: Where the puck is thrown towards an opponent's goal by the goaltender and it is received by an opponent, the Referee shall allow play to continue. However if a teammate receives the puck, play shall be stopped.
- (c) A Minor penalty shall be assessed any player (except the goaltender) who, while play is in progress, picks up the puck with her hand.
- If a player of the defending team (except the goaltender) picks up the puck from the ice while it is in her team's goal crease, the play shall be stopped and a Penalty Shot shall be awarded to the non-offending team.
- (d) A player shall be permitted to stop or "bat" a puck in the air with her open hand, or to push it along the ice with her hand and play shall not be stopped, unless the player has directed the puck to a teammate in the neutral or attacking zone. When this occurs play shall be stopped and the puck faced-off at the spot where the offense occurred, unless the offending team gains a territorial advantage, then the face-off shall be where the stoppage of play occurred, unless otherwise covered in the rules. Play shall not be stopped for any hand pass by players in their own defending zone.
- (e) A goal shall not be allowed if the puck has been batted with the hand or any part of the body by the attacking player into the net or, after being batted, the puck deflects off any player or stick into the net.

#### SITUATION 1 Rule 9.1 (c)

*The puck is in the goal crease. A player who is outside the crease, bats or scoops the puck out of the crease and into her body. She doesn't cover or grab the puck while the puck is still in the crease, just scoops it out and then grabs it or falls on it.*

#### RULING:

Assess a Minor penalty under Rule 10.3 (a) – Falling on the Puck.

#### SITUATION 2 Rule 9.1 (d)

#### QUESTION:

*The puck is batted with the hand, hits the opposing goaltender, rebounds back out and is picked up by another player of the same team batting the puck. Does play continue or is play stopped?*

#### ANSWER:

*Play is stopped. Play can only continue if the non-offending team gains "possession and control" of the puck. Since the puck only hit the goaltender (possession, but not control), play would be stopped.*

**SITUATION 3 Rule 9.1 (d)**

*A situation similar to Situation 2, except that the puck, after deflecting off the goaltender, then deflects off another defending player to an attacking player.*

**RULING:**

*Stop play. Play can only continue if the non-offending team gains "possession and control" of the puck. A deflection does not constitute "control".*

**SITUATION 4 Rule 9.1 (d)****QUESTION:**

*The puck is batted with the hand, hits the body of a teammate, then is picked up by an opposing player. Should the play continue?*

**ANSWER:**

*Yes, do not stop play, unless that teammate gains possession and control of the puck.*

**SITUATION 5 Rule 9.1 (e)**

*If an attacking player bats the puck and it is deflected into the goal by any player (attacking or defending) or goalkeeper the goal shall NOT be allowed. The key principle of this rule is that no goal can be scored when an attacking player bats the puck unless the puck is subsequently clearly "shot" into the goal. After any batted puck, the official should watch closely for a clear shooting action. If the puck enters the goal and no clear shooting action was observed, disallow the goal. The subsequent face-off after the above stoppage of play shall be in the neutral zone. To further clarify: Any attacking player that bats a puck to a teammate and:*

- *it deflects off the teammate's skate, body or stick - no goal.*
- *if it is deliberately directed into the goal by a teammate's stick, but not clearly shot - no goal. Stoppage of play should be called. Rule 9.1 (d).*
- *if it is deflected or deliberately directed (but not batted) into the net by a teammate - no goal.*
- *if it is batted by an attacking player, and then deflects off his own stick into the net - no goal.*

**SITUATION 6 Rule 9.1 (d)**

*The face-off for an infraction of a hand pass should take place at the point where the hand pass was made, in accordance with Rule 10.2 (g), or where the stoppage occurred if that penalizes the offending team more. Where an attacking player in the attacking zone, makes a hand pass and the defending team refrains from playing the puck, stop play and conduct the face-off at the place where the stoppage occurred, unless otherwise stated in the rules.*

**EXAMPLE:**

*The puck is hand passed by "A" in their own defending end. The puck rolls down the ice and is played by "A" near the centre red line. The face-off will take place where the puck was hand passed, as it penalizes "A" more than if the face-off took place where the puck was played.*

*Note: The face-off always takes place at the point penalizing the offending team the most in accordance with Rule 10.2 (g).*

**SITUATION 7**

*Where a player in the neutral or attacking zone hand passes the puck back into her defending zone and a teammate gains possession and control of the puck, play would continue.*

*Note: For the purpose of this rule, the position of the puck and not that of the player's skates determines which zone the player is in when the hand pass is completed.*

**SITUATION 8 Rule 9.1 (a)**

**GENERAL GUIDELINES FOR CLOSING YOUR HAND ON THE PUCK.**

1. A player closes her hand on the puck and then throws the puck - stop play immediately. A Minor penalty for Handling the Puck must be assessed.
2. When a player closes her hand on the puck, then tries to maneuver around another player while holding the puck or where a player is prevented from playing the puck by the player changing the general location of the puck while holding it - A Minor penalty for Handling the Puck must be assessed.
3. If a player takes a stride while holding the puck in her hand - Assess a Minor penalty for Handling the Puck.

**Rule 9.2 Harassment of Officials, Unsportsmanlike Conduct/Misconduct**

Team officials shall be responsible for their conduct and that of their players at all times. They must endeavor to prevent disorderly conduct before, during or after the game, on or off the ice and any place in the rink. The Referee may assess penalties to any of the above team officials for failure to do so and shall report full details of the incident to the President.

- a) A Minor penalty shall be assessed to any player or team official who challenges or disputes the rulings of any official during the game or who displays unsportsmanlike conduct.

If a player or goaltender persists, she shall be assessed a Misconduct penalty and any further disputes will result in a Game Misconduct penalty being assessed to the offending player or goaltender. If a team official persists, she shall immediately be assessed a Game Misconduct penalty.

A Referee is not required to assess a Minor penalty under this rule before assessing the Misconduct or Game Misconduct, but may assess either of these penalties initially.

- (b) A Misconduct penalty shall be assessed on any player who:
- (1) uses obscene, profane or abusive language or gestures to any person.
  - (2) persists in disputing or shows disrespect for the ruling of any official.
  - (3) intentionally knocks or shoots the puck out of reach of an official who is retrieving it. A player who, after receiving a Misconduct penalty, persists in any of the actions of (b) above, shall be assessed a Game Misconduct penalty.

*Note: In the case of a team official, a Bench Minor penalty shall be assessed instead of a Misconduct penalty. A team official after receiving a Bench Minor penalty would receive a Game Misconduct penalty if the actions continue. A Referee is not required to assess a Bench Minor penalty under this rule before assessing a Game Misconduct penalty.*

- (c) If the Referee is unable to identify the person responsible for the use of obscene, profane or abusive language, a Bench Minor penalty shall be assessed the offending team.
- (d) A Misconduct penalty shall be assessed any player who does not proceed immediately and directly to the penalty bench when she has been penalized. Where the penalized player causes any delay by returning for her equipment (gloves, sticks, etc...), the

Misconduct penalty shall apply. The equipment shall be delivered to her on the penalty bench by a player of her team on the ice at the time of the infraction.

*Note: It shall be necessary to place a substitute on the penalty bench. Such substitute may return to the ice as soon as the Misconduct penalty to the offending player commences.*

- (e) A Misconduct penalty shall be assessed to any player who shows any course of conduct (including threatening and abusive language or gestures or similar actions) designed to incite an opponent into incurring a penalty.
- (f) Any player or team official who engages in verbal taunts, insults or intimidation based on discriminatory grounds (race, ethnicity, religion, gender, sexual orientation, language) shall be assessed a Game Misconduct penalty.

Notwithstanding the above, at the discretion of the Referee, a Gross Misconduct penalty may be assessed for any infraction to any player or team official.

*Note: Officials must complete a game report and report to the President any penalty incurred under Rule 9.2 (f).*

- (g) A Misconduct penalty shall be assessed any player or players who, except for taking her position on the penalty bench, enters or remains in the Referee's crease while the Referee is reporting to or consulting with any game official, including the Linesmen, Timekeeper, Penalty Timekeeper, Official Scorer or Announcer.
- (h) Where a team official has been assessed a Game Misconduct penalty under this rule, the Referee shall report the individual in full details to the President, who may assess further penalties.
- (i) A Bench Minor penalty shall be assessed a team where any player or team official on the bench protests an official's ruling through verbal or physical gestures that may be considered disrespectful in any way, or who bangs the boards or ice surface with a stick or any other object in protest of the ruling.
- (j) When the player on the ice commits the infraction described in (i), the Unsportsmanlike Conduct penalty shall be assessed.

#### SITUATION 1 Rule 9.2 (a)

*There appears to be some misunderstanding as to when and how this rule should be used. You will note that this rule does not replace any other already in effect under Rule 9.2 - "Harassment of Officials, Unsportsmanlike Conduct/Misconduct", nor is it a substitute for the corresponding penalties. The Referee may assess a penalty under this rule when unsportsmanlike actions are directed against either a game official (On-ice or Off-ice Officials) or any opposing player. Any unsportsmanlike actions that are directed at an individual should be penalized promptly. The over zealous application of this rule to restrict enthusiasm displayed by a player who has made an important play or scored a goal is not the intent of this rule. Officials should not penalize enthusiasm unless it has crossed the line that separates enthusiasm from baiting, good taste or disrespect. Due to the wide scope of this rule, guidelines for judgment are difficult to describe. The preceding comments should provide some assistance for the interpretation of this rule.*

#### SITUATION 2

*Any team official who is assessed a penalty shall not be permitted to serve that penalty on the penalty bench. If a time penalty is involved, it shall be served by a player of that team who was on the ice at the time of the infraction.*



**SITUATION 3** Rules 9.2 (a)

*Where obscene, abusive or profane language is directed at the official, then a Misconduct or Game Misconduct may be assessed, without going through the unsportsmanlike conduct penalty first.*

**SITUATION 4** Rule 9.2 (i)**QUESTION:**

*What penalty is assessed a goaltender or any player who harasses the Goal Judge by banging her stick against the glass?*

**ANSWER:**

*A Minor penalty for unsportsmanlike conduct. If the action persists, assess a Misconduct or Game Misconduct.*

**SITUATION 5** Rule 9.2 (a)

*The following situations are at the discretion of the referee:*

- 1. A player who deliberately sprays snow from her skates into an opponents face (i.e., goaltender) shall be assessed a Minor penalty for unsportsmanlike conduct.*
- 2. Shooting the puck at or near the goal after-the-whistle would result in a Minor for unsportsmanlike conduct.*
- 3. Pushing or sliding the puck after the whistle could be dealt with by a warning.*
- 4. Shooting the puck out of the rink after the whistle would result in a delay of game minor.*
- 5. Shooting the puck away from linesman who is retrieving the puck would result in a Misconduct penalty under rule 9.2 (b) (3) at the discretion of the Referee.*

**SITUATION 6****QUESTION:**

*A player on the penalty or players' bench directs a choke signal at the Referee who does not observe it, however, a Linesman sees the infraction. Can the Linesman call a Bench Minor penalty? What action should the Linesman take?*

**ANSWER:**

*Technically, the Linesman cannot assess a Bench Minor penalty. She should report the incident to the Referee, who may then assess a penalty.*

**SITUATION 7****QUESTION:**

*The play is in progress and a player verbally harasses a Linesman. Can the Linesman stop the play to assess the Misconduct?*

**ANSWER:**

*The Linesman cannot stop play to assess the penalty. She must wait for a stoppage of play, then notify the Referee.*

**SITUATION 8** Rule 9.2 (a)

*In cases where a single Minor penalty has been assessed and the penalized player is guilty of unsportsmanlike conduct, the Referee is encouraged to assess the additional Minor penalty for "Unsportsmanlike Conduct". However, if a teammate on the ice is guilty of unsportsmanlike conduct, the Referee is encouraged to assess a Misconduct in this situation.*

**Rule 9.3 Diving**

A Minor Penalty for Unsportsmanlike Conduct shall be imposed on a player who attempts to draw a penalty by his/her actions (diving). This penalty may be assessed with or without a foul to the opposing team at the discretion of the Referee.

**Rule 9.4 Kick Shot**

A Minor penalty shall be assessed any player except the goaltender who uses a kick shot during the game. If an injury results, a Major Penalty and a Game Misconduct penalty shall be assessed.

**Rule 9.5 Leaving the Players' or Penalty Bench**

- (a) No player may leave the players' bench or penalty bench at any time during a fight on the ice, or for the purpose of starting a fight. Substitutions made prior to the fight shall be permitted, provided the players so substituting do not enter the fight.
- (b) For a violation of Rule 9.5 (a), a double Minor penalty shall be imposed on the player of the team who was the first to leave the players' or penalty bench during a fight. If players of both teams leave their respective benches at the same time, the first identifiable player of each team to do so, shall incur a double Minor penalty. A Game Misconduct penalty shall also be imposed on any player penalized under this section, plus any other penalties he may incur. Refer to Section (d).
- (c) Any player (other than those dealt with under Section (b)) who leaves his players' or penalty bench during a fight and is assessed a Minor, Major or Misconduct penalty for his actions, shall also incur an automatic Game Misconduct penalty, in addition to any other penalties he may incur. This includes a player leaving the penalty bench, for which he is to be assessed a Minor penalty in addition to the Game Misconduct penalty. Such player would not have to be the first player to leave a bench.

*Note 1: A maximum of 5 players per team may be assessed Game Misconducts for violations of Sections (b) and (c) of this rule during a stoppage of play. The maximum of 5 players shall include any players penalized under Rule 6.7 - Fighting and Roughing.*

*Note 2: Where one team has been clearly identified as the first to leave the bench and the Referee has assessed the 5 player maximum Game Misconducts, then in this situation a sixth player on one team may be assessed a Game Misconduct penalty under this section. This sixth player must be the player who left the bench first.*

*Note 3: Referees must record in detail on the Official Game Report or separate Penalty Report Form, any bench clearing incidents.*

**NEW (d) A Minor penalty shall be assessed any player that leaves the penalty bench or returns to the ice before the expiration of his penalty. However, in the case of a player returning to the ice prematurely due to an error by the Penalty Timekeeper, no penalty shall be assessed and the player must only serve the time remaining in his penalty at the moment he returned to the ice.**

- (e) When a player on a breakaway in the neutral or attacking zone is interfered with by a player of the opposing team who shall have illegally entered the game, or by a player or team official on the players' or penalty bench, the Referee shall award a Penalty Shot to the non-offending team.

- (f) Any team official who gets on the ice after the start of the game, without the permission of the Referee, shall be assessed, at the discretion of the Referee, a Bench Minor or a Game Misconduct penalty. If a Game Misconduct penalty is assessed, the team official shall be ordered to the dressing room for the remainder of the game and the Referee shall submit a report in full detail to the President, who may assess further penalties.
- (g) If a penalized player returns to the ice from the penalty bench before his penalty has expired, (either by his own error or the error of the Penalty Timekeeper), any goal scored by his own team while he is illegally on the ice shall not be allowed. All penalties assessed either team shall be served as regular penalties.
- (h) If a player shall illegally enter the game from his own players' bench, any goal scored by his own team while he is illegally on the ice shall not be allowed. All penalties assessed either team shall be served as regular penalties.

**NEW (i) At the end of each period, all players must remain on their respective players' or penalty bench until directed off by the Referee. The Visiting Team shall leave the ice first, unless otherwise directed by the Referee. Failure to comply shall result in a Bench Minor penalty. Any unusual circumstances shall be reported to the President.**

**A Game Misconduct penalty shall be assessed to the coach of any team that fails to comply with this rule at the end of the game if an altercation that results in penalties of any kind is either in progress as the game ends or begins after the game has ended.**

*SITUATION 1 Rule 9.5 (d)(e)*

**QUESTION:**

*What would happen if a player who enters the game illegally from the penalty bench, by reason of the Timekeeper's error, checks a player who has a breakaway in the neutral or attacking zone.*

**ANSWER:**

*A Penalty Shot would be awarded. The Minor penalty for leaving the penalty bench before the expiry of a penalty would not be applied and the player would simply return to the penalty bench to serve the amount of time remaining in the penalty when he left the bench (even if a goal is scored on the Penalty Shot).*

*SITUATION 2 Rule 9.5 (d)(e)*

**QUESTION:**

*What penalty would be assessed to a player who on his own leaves the penalty bench before the expiry of his penalty, and checks a player who has a breakaway, in the neutral or attacking zone?*

**ANSWER:**

*Award a Penalty Shot. The player leaving the penalty bench early would be assessed a Minor penalty to be served after his original time is up.*

*SITUATION 3*

*In the case of Situation 2, let us assume that the player scores on the breakaway. The remainder of the original Minor penalty would be washed out, but the Minor penalty for leaving the penalty bench early and the Minor, Major or Match penalty (originally calling for the Penalty Shot) would still be assessed.*

## SITUATION 4

*In the case of Situation 2, let us assume that the penalized team is two players shorthanded. One player (#4) has 1:00 remaining in his Minor penalty and the other player (#13) has 1:30 remaining in his Minor penalty. Player #13 leaves the penalty bench early and checks an opposing player who is on a breakaway in the neutral or attacking zone.*

## RULING:

- (a) *If he scores - #4's penalty would expire on the goal and #13 returns to the penalty bench to serve the remainder of his original Minor penalty, is assessed an additional Minor penalty for leaving the penalty bench early and a Minor or Major penalty for the infraction that would have originally called for a Penalty Shot.*
- (b) *If he doesn't score - Award a Penalty Shot and #13 returns to the penalty bench to serve the remainder of his original Minor penalty and is assessed an additional Minor penalty for leaving the penalty bench early.*

## SITUATION 5 Rule 9.5 (b)

## QUESTION:

*A player of Team "A" leaves the players' bench during a fight. He is the first player to leave a bench. He gets into a fight with an opposing player already involved in the fight. What penalties would be assessed?*

## ANSWER:

*The player who leaves the players' bench would receive a double Minor for being the first player for leaving the bench, plus a Game Misconduct, as well a Major penalty and an additional Game Misconduct, under Rule 6.7 (a) - Fighting and Roughing. He would also be assessed a third Game Misconduct for taking part in another fight during the same stoppage of play, under Rule 6.7 (h).*

*The original two players who were fighting would both receive Majors and Game Misconducts for fighting. The player who becomes involved in the second fight would receive a second Major and Game Misconduct for the second fight. Finally, he would be assessed a third Game Misconduct for becoming involved in a second fight during the same stoppage of play, under Rule 6.7 (h) - Fighting and Roughing.*

*Note: When a situation arises that warrants the assessment of multiple Game Misconducts to a player, officials must ensure that each one is assessed and recorded on the Official Game Report, but have only one Game Misconduct per player announced on the P. A. system.*

## SITUATION 6 Rule 9.5 (d)

*If a player serving a Misconduct comes on the ice before his penalty has expired, he would receive a Minor penalty. Put a man in the box to serve the Minor penalty immediately and delay the Misconduct for 2 minutes. After the Minor is over, the balance of the Misconduct can be completed.*

## SITUATION 7 Rule 9.5 (a), (b), and (d)

*Where the first player to leave a bench comes from the penalty bench, he shall be assessed 2 plus 2 plus 2, plus a Game Misconduct plus any other penalties he may be assessed under the rules. He receives a double Minor and Game Misconduct for being the first player to leave the penalty bench, plus another Minor for leaving before his penalty expires. If the benches empty, Rule 6.7 (g) would not apply, however the officials should make every attempt to get the players back to their respective benches.*

## SITUATION 8

*An incident occurs on the ice where a player is assessed a Match penalty. During that stoppage of play, the benches clear during a fight on the ice. How many penalties will be served?*

**RULING:**

*Rule 9.5 (c) - Note 1 stipulates that a maximum of 5 players per team may be assessed Game Misconduct during one stoppage of play, for violations of Rule 9.5 (b)(c). This would then apply. In addition, the Match penalty would be assessed and served in the normal manner, regardless of the number of Game Misconduct's already assessed a team. The player receiving the Match penalty may or may not be one of the players assessed a Game Misconduct.*

*Note: In situations where players leave the bench during a fight on the ice and the maximum of 5 players per team are assessed Game Misconducts for violations of Rule 9.5 (b) (c), it is still possible to assess Minor, Major, Misconduct, Game Misconduct (for an infraction to any rule other than Rule 9.5 (b)(c)), Gross Misconduct or Match penalties to players other than those included in the "maximum of 5 ejections" category.*

## SITUATION 9 Rule 9.5 (c) - Note 1

*This Note stating that a maximum of 5 players per team may be assessed a Game Misconduct for violations of Sections (b) and (c) of this rule, may be applied more than once a game.*

## SITUATION 10 Rule 9.5 (c) Note 2

*This Note states that six players on a team may be assessed a Game Misconduct when only one team is clearly identified as the first to leave the bench.*

*Note: When all 12 players on the ice (5 players on the ice plus the two goaltenders) are fighting, and only one team leaves the bench, or where a team is clearly identified as the first to leave the bench, then a sixth Game Misconduct (and the associated double Minor) would be assessed that team. The penalty would be to the player who was first to leave the bench.*

## SITUATION 11 Rule 9.5 (f)

*Where a Manager or Coach is ordered to the dressing room, it is sufficient if he is away from the bench and not directing the team in any manner and in no way bothering the officials. This means he does not have to stay in the dressing room.*

## SITUATION 12 Rules 9.5 (d)(g)

*If the Timekeeper or Penalty Timekeeper permits a player to return to the ice before his time has actually expired, this error must be corrected during the first stoppage of play following the actual time when the penalty should have expired. If the error was not discovered until after play resumed following this stoppage (and the actual penalty time had expired), then no adjustment shall be made if the error was discovered at a later period of time. The player will not be required to serve the unexpired time. All goals scored by his team shall count. If the error is reported during this first stoppage of play, the player would be required to serve the unexpired time (amount of time remaining in the penalty when the player left the bench), and any goal scored by his team while he is illegally on the ice shall not be allowed.*

**EXAMPLE A:**

*A player of Team "A" received a Minor penalty at 8:30. At 7:00, due to a Timekeeper's error, the player left the box. At 6:30, the penalty would have been up. Team "A" scored at 5:45 with the player on the ice. This is the first stoppage of play since the Timekeeper's error and this error is immediately brought to the attention of the Referee.*

**RULING:**

*The goal would be allowed, as the actual penalty time was up when the goal was scored, but the player would be required to return to the penalty box to serve his remaining 30 seconds.*

**EXAMPLE B:**

*A player of Team "A" received a Minor penalty at 8:30. At 7:00, due to a Timekeeper's error, the player left the box. Team "A" scored at 6:40. At 6:30 the penalty would have been up. When Team "A" scored at 6:40, which was the first stoppage of play, the error was discovered.*

**RULING:**

*Since the player of Team "A" was illegally on the ice, as there was still time remaining in his penalty, the goal would not be allowed and the player would be required to return to the penalty box to serve the 30 seconds that he had not served previously.*

**EXAMPLE C:**

*A player of Team "A" received a Minor penalty at 8:30. At 7:00, due to the Timekeeper's error, the player left the box. At 6:40, Team "A" scored and at 6:30 the actual penalty time should have expired. At 5:50, the next stoppage of play, the Timekeeper's error was discovered and reported to the Referee.*

**RULING:**

*The goal shall not be allowed and the player shall be required to go back to the penalty box to serve the 30 seconds remaining in his penalty. The reason for this ruling is that the stoppage of play at 5:50 is actually the first stoppage of play following the actual time when the penalty should have expired. The goal at 6:40 was not actually the first stoppage of play.*

**SITUATION 13 Rule 9.5 (g)**

*If a player leaves the penalty bench before his penalty time has expired and that player is fouled in any manner, the appropriate penalty shall be assessed and the player would return to the penalty bench. The only exception would be that no Penalty Shot or Goal may be awarded in this situation, as a goal may not be scored by his team, while the penalized player is illegally on the ice.*

**SITUATION 14 Rule 9.5 (g)**

*Where a player has left the penalty box through his own error before his penalty has expired, any goal scored by his team shall be disallowed and the appropriate penalty assessed. This would hold true even if the goal was scored after the regular time for the penalty has expired and the player could have legally been on the ice. In essence, it is to be regarded as a delayed penalty.*

**SITUATION 15**

*Where a player returns to the ice from the penalty box through his own error, before his penalty has expired and the other team scores a goal while he is still illegally on the ice. Does the goal count and would it cancel the penalty?*

**ANSWER:**

1. *The goal would count.*
2. *The goal would cancel the unexpired penalty. The player would still have to go back to the penalty box to serve the penalty for leaving the penalty box too soon.*

**SITUATION 16 Rule 9.5 (a)**

*No player may leave the players' bench for the purpose of starting a fight.*

**EXAMPLE:**

*On a stoppage of play, Team A8 comes off the players' bench on a player change. Before play resumes he becomes involved in a fight with Team B6.*

**QUESTION:**

*What penalties are assessed if:*

- i) Team A8 initiates or instigates the fight and both players fight.*
- ii) A fight takes place with both players being willing participants.*
- iii) A fight takes place with Team B6 being the instigator.*

**RULING:**

- i) A8 double Minor plus Game Misconduct for leaving players' bench for purpose of starting a fight, plus Minor for instigator, plus fighting Major + Game Misconduct. B6 receives a fighting Major plus Game Misconduct.*
- ii) A8 would not receive the instigator Minor. All other penalties would remain the same as in (i) above.*
- iii) A8 would only receive a fighting Major and Game Misconduct. B6 would receive a Minor for instigator, plus a fighting Major plus Game Misconduct.*

*Note: Rule 9.5 (a) Double Minor plus Game Misconduct penalties can not be assessed unless at least one Fighting Major has been assessed during this altercation.*

**SITUATION 17**

*With 1:20 remaining in the third period, two players, one from each team, are assessed Minor penalties (coincidental). They are sent to their respective dressing rooms without incident. With 3 seconds left in the game, a fight breaks out on the ice and one of the players that left with 1:20 remaining comes back on the ice and gets involved in the fight(s).*

**QUESTION:**

*What is the ruling?*

**ANSWER:**

*This must be regarded as a special situation and therefore reported as such to the President. However, the player returning to the ice could still accumulate time penalties. There are a number of interesting possibilities:*

- 1. In all cases where a penalized player returns to the ice from the dressing room (or after having been escorted off the ice to go to the dressing room) during a fight on the ice, that player shall be assessed a Gross Misconduct plus any other penalties he may incur.*
- 2. If he was the first player to come on the ice he would be assessed a double Minor penalty plus a Game Misconduct for being the first player off the bench, plus a Gross Misconduct (as indicated in (1) above), plus any other penalties that he incurs.*
- 3. Should a non-penalized player return to the ice from the dressing room during a fight on the ice, he would be considered as a player coming off the players' bench and penalized accordingly.*

**SITUATION 18**

*When a player who is serving a coincidental penalty comes on to the ice before his penalty has expired through his own error, he would receive a Minor penalty. Assuming there are no other infractions, put a player from the ice in the penalty box to serve the additional Minor penalty immediately and delay the balance of the coincidental penalty for two minutes.*

**SITUATION 19**

*A5 minor penalty at 8:00 A5 leaves penalty bench (on his own) at 6:15 (15 sec. early) Play is stopped at 5:30 for a minor penalty to B4. Referee also assesses the minor penalty to A5 at same time for leaving the penalty box early.*

**RULING:**

*The minor penalties assessed to B4 and A5 at 5:30 would be coincidental. A player from the ice will serve the remaining 15 seconds of the original minor penalty to A5. Therefore Team "B" will have a power play 5 on 4 for 15 seconds. A5 serves the 2 min coincidental plus 15 seconds of unexpired time.*

**SITUATION 20 Rule 9.5 (i)**

*Where one or both teams have players in the penalty box at the end of the period, they must remain in the box until directed by the Referee to leave. The player(s) would be released with their respective teams.*

**SITUATION 21 Rule 9.5 (i)**

*Although this rule is not intended to prevent a team from showing enthusiasm for a victory at the conclusion of the game, the Referee, could inform both benches to follow this procedure. Failure of the team(s) to comply should be reported to the President.*

**Rule 9.6 Physical Harassment of Officials**

- (a) Any player or team official who threatens or attempts to strike a Referee, Linesman or any Off-ice Official before, during or after a game shall be assessed a Match penalty and shall be reported to the President by the Referee.
- (b) Any player or team official who intentionally touches, holds or pushes a Referee, Linesman or Off-ice Official before, during or after a game shall be assessed a Match penalty and shall be reported to the President by the Referee.
- (c) Any player or team official who deliberately strikes, trips or body checks a Referee, Linesman or Off-ice Official before, during or after a game shall be assessed a Match penalty and shall be reported to the President by the Referee. Such player or team official may be suspended for one year or more.

**SITUATION 1****QUESTION:**

*A player in the penalty box grabs a Timekeeper or any Off-ice Official. What penalty is to be assessed?*

**ANSWER:**

*A Match penalty must be assessed.*

**SITUATION 2**

*This Rule and Rule 9.2 - Harassment of Officials and Other Misconduct - shall both apply whenever a Stand-by Official has been appointed to a game and where that Stand-by Official has been harassed or molested by any player or team official.*

**Rule 9.7 Spitting**

A Match penalty shall be assessed any player or team official who deliberately spits on or at an opponent, official, team official or spectator. The Referee shall report full details of the incident to the President.



**SITUATION 1**

*Where a team official has been removed from the bench and ordered to the dressing room for a spitting infraction, the offending team would be required to place a player on the penalty bench to serve the five minute time penalty. That player would have to be selected from the players on the ice at the time of the infraction.*

**Rule 9.8 Throwing Stick or Object**

- (a) Where any player of the defending team, including the goaltender, deliberately throws his stick or any part thereof or any other object at the puck or puck carrier in the defending zone, the Referee shall allow the play to be completed and, if a goal is NOT scored, a Penalty Shot shall be awarded to the attacking team. If a goal is scored, the Penalty Shot shall not be awarded.
- (b) A Minor penalty shall be assessed any player who deliberately throws his stick or any part thereof or any other object at the puck or puck carrier in any zone, except when such act has been penalized by the awarding of a Penalty Shot or a Goal.
- (c) A Minor penalty for Throwing a Stick/Object (as applicable) shall be assessed any player who deliberately throws his stick or any part thereof or any other object in any zone, but not at the puck or puck carrier.
- (d) A Misconduct penalty shall be assessed any player who deliberately throws a stick or any part thereof or any object, outside the playing area.

**SITUATION 1 Rule 9.8 (b)**

*The penalty to be assessed is determined by the location of the puck or puck carrier when the stick contacts either the puck or the puck carrier. However, it should be remembered that the stick may not reach the puck or puck carrier and the appropriate penalty would still be assessed.*

**EXAMPLES:**

- (a) *If a player had possession of the puck in the neutral zone and an opposing player who is located in any one of the defending, neutral or attacking zones throws his stick or any other object at the puck or puck carrier, the penalty to be assessed would be a MINOR PENALTY, except when such act has been penalized by the awarding of a Penalty Shot as in example (c) below.*
- (b) *If a player has possession of the puck in his attacking zone and an opposing player who is located in any one of the defending, neutral or attacking zones throws his stick or any object at the puck or puck carrier, a PENALTY SHOT would be awarded.*
- (c) *If a player has possession of the puck in the neutral zone and an opposing player who is located in any one of the defending, neutral or attacking zones throws his stick or any other object at the puck or puck carrier, and during the time elapsed between the actual throwing of the stick and the time when the stick actually reaches the puck or puck carrier, that puck (or puck carrier) has reached the attacking zone, then a PENALTY SHOT shall be awarded.*

**SITUATION 2 Rule 9.8 and Rule 4.10 (a) - Awarded Goals**

*A goal shall be awarded to the attacking team if a stick or any part thereof or any other object is thrown by a defending player at an opponent in control of the puck on a breakaway in the neutral or attacking zone, preventing a shot at the open goal.*

*Note: An open goal is defined as one from which the goaltender has been removed, for an additional attacking player.*

### SITUATION 3

*A goaltender throws his stick at the puck in his own defending zone. The puck is not in the possession of an attacking player and was last in possession of a defending player.*

**QUESTION:**

*What player of the non-offending team would be awarded the Penalty Shot?*

**ANSWER:**

*Any player of the non-offending team who was on the ice at the time of the infraction could take the shot, as stipulated in Rule 4.9 (c).*

### SITUATION 4

**QUESTION:**

*Can a player kick a stick that is on the ice back to his goaltender or another teammate without being assessed a penalty?*

**ANSWER:**

*Yes - provided the kicked stick does not interfere with the play or an opposing player. (This is consistent with the guidelines for shooting a stick back to a teammate as described in Rule 3.2 Situation 5).*

### SITUATION 5 Rule 9.8

*A stick is thrown to a player on the ice by a teammate who is also on the ice. The player picks up the stick.*

**RULING:**

*Assess a Minor penalty to the player throwing the stick, and assess a Minor penalty for "illegally receiving a stick", to the player who picks up the stick.*

### SITUATION 6

*Where a player throws his stick at an opposing player, whether or not he has the puck, assess a Minor penalty for Throwing the Stick (or Penalty Shot as appropriate). If the opposing player is injured by the thrown stick, assess the guilty player a Major penalty and Game Misconduct for Interference. A Match penalty may be assessed if, in the opinion of the Referee, there was either deliberate attempt to injure or deliberate injury. See Rule 7.3 (e).*

### SITUATION 7 Rule 9.8 (a)(b)

*Where a stick is thrown by a defending player in the neutral zone and another stick is thrown at the puck or puck carrier by a defending player in his defending zone, a Minor penalty shall be assessed and a Penalty Shot shall be awarded. Should the player fouled score on the Penalty Shot, the Minor penalty shall still be assessed for the first infraction in the neutral zone.*

### SITUATION 8

*The goaltender is out of the goal (in the corner or on his way to the bench) and a stick is thrown at the loose puck by the defending team. Such a situation would call for a Minor penalty or a Penalty Shot depending on the location of the puck when the stick is thrown.*

**QUESTION:**

*Since the goaltender is out of the net, do you award a goal?*

**ANSWER:**

*No, the determining factor in whether a goal is awarded is the substitution of the goaltender. If the goaltender is anywhere on the ice and no substitute has replaced him, then only a Minor penalty or a Penalty Shot would be called.*

**SITUATION 9**

**QUESTION:**

*Can a Linesman report a stick throwing infraction when a player has thrown his stick at the puck or puck carrier and the Referee has not observed this infraction.*

**ANSWER:**

*No. As this is a Minor penalty.*

**QUESTION:**

*What if this infraction occurs in a teams defending zone.*

**ANSWER:**

*The Linesman may not assess a Penalty Shot. Rule 5.3 (d).*

## SECTION 10 GAME FLOW

### Rule 10.1 Delay of Game

- (a) A Bench Minor penalty shall be assessed a team which, in the opinion of the Referee, is deliberately delaying the game in any manner.

A Minor penalty shall be assessed to any goaltender who shoots or bats the puck out of the playing surface with her stick.

*Note 1: When the goaltender shoots the puck directly out of the playing surface where there is no glass, such as at the players' bench or penalty bench, or if the puck touches the glass or deflects off a player or official, no penalty shall be assessed.*

*Note 2: This penalty will also be assessed to any player or goaltender who shoots the puck out of the playing surface with her stick during a stoppage of play.*

*Note 3: Referees must be strict in enforcing the rules where a team is deliberately stalling, freezing the puck, shooting the puck out of the playing surface, the goaltender holding the puck or throwing it out of the playing surface, or the team committing a "SERIES of ICING", thereby forcing a face-off.*

- (b) Any player who leaves her players' bench to deliver instructions to her teammates and does not remain on the ice as a substitute, will be assessed a Minor penalty.
- (c) Any deliberate action by a defending player, including the goaltender, in their defending zone which results in the goal net being knocked from its position, shall constitute an act of deliberate delay of game. If this action occurs in the last two minutes of regular playing time, or any time in overtime, a Penalty Shot shall be awarded against the offending team and the Minor penalty shall not be served.
- (d) A Penalty Shot shall be awarded should the goaltender, by deliberate action, dislodge the goal net from its position when a player is on a breakaway in the neutral zone or attacking zone.
- (e) If in the last two minutes of regular playing time, or anytime in overtime, a team is penalized for any of the following infractions, a Penalty Shot shall be awarded against the offending team: Deliberate Illegal Substitution - Rule 2.5 (f), Protective Equipment - Rule 3.6 (c), Deliberately Knocking the Goal Net from its Position - Rule 10.1 (c), Refusing to Start Play - Rule 10.14 (a), Rule 10.14 (e).

*Note: In overtime, a Penalty Shot shall be assessed under this rule, except in the case of Rule 10.14 (a) - Refusing to Start Play, in which case a Penalty Shot and a Major Penalty plus a Game Misconduct shall be assessed.*

- (f) A Bench Minor penalty shall be imposed upon any team which, after a warning by the Referee, fails to place the correct number of players on the ice and commence play.

#### SITUATION 1 Rule 10.1 (c)

*When a goal has been displaced intentionally or otherwise, the Referee or Linesman will use the following criteria to determine when play should stop:*

- (a) *If the puck is in the same end zone where the goal has been displaced, stop play immediately. If the goal has been displaced intentionally, then assess the appropriate penalty.*
- (b) *If the goal is displaced by a player whose team is in control of the puck, call the play at once.*
- (c) *If a team has control of the puck in the neutral zone and is moving up the ice and a player on the opposing team in her attacking zone displaces the goal, let play continue*

*until the scoring play by the non-offending team has been completed. If the team in control of the puck, moves the puck back into their own zone, with their goal displaced, then call the play at once.*

*Note: In this case a goal may be scored at one end of the ice, even though the net at the opposite end has been displaced.*

#### SITUATION 2

*When the defending player intentionally knocks the goal off its mooring, a Minor penalty for Delay of Game shall be assessed or a Penalty Shot awarded. A defending player is defined as a player in her defending zone, regardless of which team is in control of the puck. When an attacking player intentionally knocks the goal off its mooring a Minor penalty for Delay of Game shall be assessed under Rule 10.1 (a). An attacking player is defined as a player in her attacking zone, regardless of which team is in control of the puck.*

#### SITUATION 3 Rule 10.1 (e)

*Where reference is made in the rules to the “last two minutes of regular playing time”, this time starts at the 2:00 time mark for the purpose of awarding a Penalty Shot.*

#### SITUATION 4 Rule 10.1 (c)

*In cases where devices are used to hold the goals in place, officials are advised to watch closely when players and goaltenders are delaying the game by knocking the goals off their mooring(s). When this action is intentional, penalize it accordingly.*

#### SITUATION 5 Rule 10.1 (c)

##### QUESTION:

*The goaltender on her way to the players' bench to be substituted by another player, intentionally knocks the net off its moorings as she leaves the goal crease. The Referee has observed the situation. What should the call be?*

##### ANSWER:

*In this situation the Referee should penalize the goaltender, by assessing a Minor penalty. If such action occurs in the last two minutes of regular playing time, or at anytime in overtime, a Penalty Shot shall be awarded against the offending team.*

#### SITUATION 6 Rule 10.1 (a) Note 1

##### QUESTION:

*What do you do in a rink where there is glass at one end of the rink but not at the other?*

##### ANSWER:

*In order for Rule 10.1 (a) to apply, both ends of the rink must be similar. If there is glass at one end only, then the rule would not apply.*

#### SITUATION 7 Rule 10.1 (a) Note 1

##### QUESTION:

*Can you apply the guideline for the goaltender shooting or batting the puck out of the rink if the rink only has glass on one side of the ice?*

##### ANSWER:

*Yes.*

##### RATIONALE:

*As long as both ends of the rink are similar, then it would be the same for both teams and so you could apply the rule. A lot of rinks have glass only on one side of the ice because they only allow spectators on one side.*

*Note: The Minor penalty for Delay of Game can still be applied even when there is no glass if the action was flagrant or deliberate in accordance with the normal interpretation of Rule 10.1 (a).*

## Rule 10.2 Face-offs

- (a) A face-off shall take place when the Referee or Linesmen drops the puck on the ice between the sticks of the players facing-off.

The players taking the face-off shall stand squarely facing their opponents' end of the rink, approximately one stick length apart with the full blade of the sticks flat on the ice. All other players on both teams must be at least 4.57m (15 ft. ) from the players taking the face-off and they must be on-side. When the face-off takes place at any of the face-off spots in the end zones, the players taking part in the face-off shall take their positions so that they will stand squarely facing their opponents' end of the rink, and clear of the face-off restraining lines.

The sticks of both players facing-off shall have the toe of the blade touching within the designated white area and the player of the Visiting Team shall place her stick within the designated white area first. All other players on the ice must position themselves and their sticks on side. If a player, other than the player taking the face-off, moves off-side, makes physical contact with an opponent or encroaches on the face-off circle prior to the dropping of the puck, then the offending team's player taking the face-off shall be ejected from the face-off.

- (b) In the conduct of a face-off anywhere on the playing surface, no player facing-off shall make any physical contact with her opponent's body by means of her own body or by her stick, except in the course of playing the puck, after the face-off has been completed. For a violation of this rule, the Referee shall assess a Minor penalty or penalties on the player(s) whose action(s) caused the physical contact.

*Note: "Conduct of a face-off" commences when the Referee designates the place of the face-off and she or the Linesman takes her position to drop the puck.*

- (c) If a player facing-off fails to take her proper position immediately when directed by the Referee or Linesman, the official may order her replaced at the face-off by any player on the ice. No substitution of players shall be permitted until the face-off has been completed and play has resumed, except when a penalty is imposed which will make a team short-handed.

When a team commits a face-off infraction (late arrival, not immediately taking a proper position, early movement), the Referee or Linesman shall require where possible for this face-off, that the replacement for the player ejected from the face-off shall be any other player on the ice that has not committed a face-off infraction during this same stoppage of play.

- (d) A team committing a second violation of any of the provisions of Section (a) during the same face-off may be assessed a Minor penalty for "face-off violation" by the Referee.
- (e) When an infringement of a rule has been committed or a stoppage of play has been caused by an attacking player in her attacking zone, the ensuing face-off shall be in the neutral zone at the nearest face-off spot.

*Note: This includes a stoppage of play caused by a player of the attacking side shooting the puck on the back of the defending teams' net without any intervening action by the defending team.*

- (f) When an infringement of any rule has been committed by players of both teams, the ensuing face-off shall be at the place where stoppage of play occurred, unless otherwise stated in the rules.
- (g) All face-offs in the neutral zone shall be conducted at the designated face-off spots as dictated by reason for the stoppage of play.

The face-off location will be at one of the two face-off spots nearest the offending team's blue line, thus causing a loss of territorial advantage.

When a stoppage of play occurs between the end zone face-off spots and the nearest end of the rink, the face-off shall be the nearest end zone face-off spot, unless otherwise stated in the rules.

Centre ice face-offs will be only conducted at the start of each period, following the scoring of a goal, premature substitution of the goaltender or in accordance with Rule 10.5 (f).

Any other stoppage of play in any zone not caused by either team, the ensuing face-off shall be at the nearest face-off spot excluding the centre face-off spot.

- (h) When any stoppage of play in the end zone is caused by a defending player or the goaltender, the ensuing face-off shall take place at the nearest defending zone face-off spot based on the cause of the stoppage of play and not related to the location of the puck when play was stopped.
- (i) When a goal is illegally scored as a result of the puck being deflected off the Referee or Linesman DIRECTLY into the net, the face-off shall take place at the nearest end-zone face-off spot.
- (j) When one or both defensemen, point players or any player coming from the players' or penalty bench of the attacking team, enter deeply into the attacking zone (the top of the circle being the limit) when a gathering is taking place following a stoppage of play, the ensuing face-off shall take place at the nearest face-off spot in the neutral zone, near the blue line of the defending team.

#### **SITUATION 1 Rule 10.2 (a)**

*A goaltender may not participate in a face-off.*

#### **SITUATION 2**

##### **QUESTION:**

*The Linesman is set to drop the puck which is subsequently knocked out of her hand by one of the players taking the face-off. What procedure does the Linesman follow?*

##### **ANSWER:**

*The Linesman conducting the face-off should blow her whistle and remove the offending player from the face-off.*

#### **SITUATION 3 Rule 10.2 (a)**

*Where the visiting team player has her stick down and is ready, the home team player must immediately put her stick down and be stationary or be removed.*

## SITUATION 4 Rule 10.2 (d)

*It is possible that on a second violation the Referee may assess a penalty for face-off violation. The Linesman should continue conducting a proper face-off until the Referee reacts. This situation would also include if a second center from the same team is ejected from a face off because of the 5 second rule not being met as per Rule 2.5 (g).*

## SITUATION 5

## PROCEDURE:

*The determining factor as to what end zone face-off spot a face-off will take place, is determined by the side of the ice on which the puck is shot, unless it is frozen on the ice by the goaltender, in which case the face-off will take place on the side of the ice that the goaltender froze the puck.*

## SITUATION 6 Rule 10.2 (a), 10.2 (d)

*In the case of player movement in preparing for end zone face-offs, the attacking team must be first to take their position, the defending team has the right to set up their defence, subsequent to the attacking players taking their position. For a violation of this rule, a warning shall be issued to that team, a subsequent violation during the same stoppage of play may result in a Minor penalty for Delay of Game.*

## SITUATION 7

## QUESTION:

*The puck is shot by a player from behind her own blue line down the ice. A teammate, who is over the centre red line, does not touch the puck but skates down the ice and precedes the puck across the attacking blue line. Off-side is called. Where does the face-off take place?*

## ANSWER:

*The puck shall be faced-off at the point from which the puck was shot, in accordance with Rule 10.2 (g), with the limit being the face-off spot in the defending end zone of the team shooting the puck.*

## SITUATION 8

## QUESTION:

*The Linesman signals a delayed off-side.*

- (a) The defending player shoots the puck directly out of the playing surface from her defending zone over the boards in the neutral zone. Where does the face-off take place?*
- (b) The defending team shoots the puck directly out of the playing area in the defending zone. Where does the face-off take place?*
- (c) The defending goalkeeper makes a save and deflects the pucks out of the playing surface, on a puck that is shot in while a player is offside. The zone has been cleared and the Linesman has lowered his arm prior to the puck leaving the playing surface. Where does the face-off take place?*

## ANSWER:

- (a) The face-off takes place at the point from which the puck was shot, in accordance with Rule 10.2 (g), as the delayed off-side ceased once the puck entered the neutral zone.*
- (b) The face-off takes place at the face-off spot outside the defending team's blue line. The delayed off-side takes precedence in this case as the puck is already illegally in the zone.*
- (c) The face-off takes place at the end zone face-off spot, as the delayed offside was no longer in effect.*



## SITUATION 9

**QUESTION:**

*The Linesman signals a delayed off-side. The defending team ices the puck. Where does the face-off take place?*

**ANSWER:**

*The face-off takes place at one of the end zone face-off spots, as in regular icing.*

## SITUATION 10

**QUESTION:**

*Where is the face-off when the puck strikes an official and goes out of the playing surface?*

**ANSWER:**

*The face-off takes place at the place where the puck goes off the official in accordance with Rule 10.2 (g), IN EVERY INSTANCE.*

## SITUATION 11

**QUESTION:**

*Team "A" is short-handed by reason of a Minor penalty. Team "B" is assessed a delayed Minor penalty in their attacking zone. Team "A" intentionally abstains from playing the puck to let the time run out on their own penalty. The Referee stops the play. Where does the face-off take place?*

**ANSWER:**

*The face-off will take place at the nearest end zone face-off spot of the team abstaining from playing the puck (Team "A"), in accordance with Rule 10.10 – Puck Must Be Kept in Motion.*

## SITUATION 12 Rule 10.2 (e)

**QUESTION:**

*If an attacking player is penalized (time penalty or not) in her attacking zone after there has been a stoppage of play in that zone, where is the face-off?*

**ANSWER:**

*The face-off will take place at the nearest face-off spot in the neutral zone.*

## SITUATION 13 Rule 10.2 (e)

**QUESTION:**

*The Referee has signaled a delayed penalty against the attacking team. The defending team (non-offending team) has control of the puck in its own defending zone and is then responsible for the stoppage of play in its own defending zone. Where does the face-off take place?*

**ANSWER:**

*The face-off takes place at the nearest face-off spot in the neutral zone.*

## SITUATION 14 Rule 10.2 (e)

*The Referee has signaled a delayed penalty on a player of Team "A". Team "B" shoots the puck into Team "A's" end zone which results in the Linesman signaling a delayed off-side. Team "A" gains possession of the puck resulting in a stoppage of play for the delayed penalty.*

**QUESTION:**

*Where is the resulting face-off?*

**ANSWER:**

*The puck shall be faced-off at the point from which the puck was shot, in accordance with*

*Rule 10.2 (g). Note: This same principal would apply if the defending team is called for high sticking the puck in their defending zone during a delayed off-side.*

**SITUATION 15 Rule 10.2 (e)(f)**

*Any time an attacking player is assessed a penalty in the attacking zone, the face-off is to take place at the nearest face-off spot in the neutral zone, regardless of the team responsible for the stoppage of play, unless players of both teams are assessed penalties or again unless the player of the non-offending team abstains from playing the puck (see Rule 10.2, Situations 9 and 12).*

**SITUATION 16 Rule 10.2 (e)**

*The player of the attacking team is assessed a penalty in her attacking zone, thereby forcing the face-off to the neutral zone. Before play resumes a player of the defending team commits a foul and is assessed a penalty.*

**RULING:**

*The Referee shall move the face-off back to the location where play was stopped in accordance with Rule 10.2 (f) as players from both teams are now receiving penalties.*

**SITUATION 17 Rule 10.2 (f)**

*When both attacking and defending players are assessed penalties and the stoppage of play occurs in the end zone, the face-off is to take place in that zone, regardless of whether or not the same number of players on each team receive penalties, unless some other rule applies that would cause the face-off to take place in the neutral zone.*

**SITUATION 18 Rule 10.2 (c)**

*Where a player has been removed from a face-off, due to failure in taking up her proper position or because of encroachment, Referees shall not permit player changes by either one or both teams. As the rule states, NO change of players is permitted until there has been a proper face-off and play has resumed. This applies to both teams, whether or not both players have been previously removed from participating in the face-off.*

**SITUATION 19 Rule 10.2 (c)**

*The only exception to the rule forbidding changes after a false start is when a penalty is assessed which will make a team short-handed.*

*EXAMPLE 1: When the on ice strength goes from 5 on 5, to 5 on 4 (or 4 on 4 to 4 on 3), both teams can change players.*

**EXAMPLE 2:**

*When the on ice strength goes from 5 on 4 to 4 on 4 (or 4 on 3 to 3 on 3), no changes may be made by either team as they are now at equal strength.*

**EXAMPLE 3:**

*When the on ice strength goes from 5 on 5 to 4 on 4 (or 4 on 4 to 3 on 3) no changes may be made by either team.*

**EXAMPLE 4:**

*Where one team is assessed a Misconduct, that team is allowed to substitute for that player, but only that team may substitute a player.*

**SITUATION 20 Rule 10.2 (a)**

*If a player, not taking the face-off, moves into the face-off circle before the puck is dropped (encroachment), then that player's teammate who is taking the face-off must be removed. Any other player of that team, other than the goalie may now take the face-off. The player*

who moved into the face-off prematurely must be identified clearly as the player causing the violation. The player who encroached is not eligible to take the face-off.

*Note: Encroachment principles could apply for face-offs at any location in all zones.*

**SITUATION 21 Rule 10.2 (a)**

*The visiting team player should put her stick in the face-off spot first. If the home team player wishes to put her stick down first, she is allowed to do so if it does not cause a problem. If there is a problem then apply the rule strictly.*

**SITUATION 22**

*In all situations where a Penalty Shot has been awarded, but for any reason no goal is scored, the face-off shall take place at either end face-off spot in the defending team's zone as stated in Rule 4.9 (g) – Penalty Shot. This includes the situation where a Penalty Shot has been awarded and the player designated to take the Penalty Shot has had her stick requested to be measured and found to be illegal. Even though the Penalty Shot was not taken (as the illegal stick denied the player that right), the face-off would still take place at either end zone face-off spot in the defending team's zone. If, after a Penalty Shot has been taken and no goal was scored, the defending team requests the measurement of a stick of a player on the ice prior to the resumption of play and the stick is found to be illegal, then the Minor penalty shall apply and the face-off shall take place at either end zone face-off spot in the defending team's zone. If, after a Penalty Shot has been taken and again no goal was scored, the team awarded the Penalty Shot commits any type of infraction calling for a penalty, then the face-off shall still take place at either end zone face-off spot in the defending team's zone.*

**RATIONALE:**

*As long as penalties are being assessed to both teams at the same stoppage of play, the face-off would remain in the defending zone, as per Rule 10.2 (f). It is only when the attacking team is receiving the only penalties assessed that the face-off would move to the neutral zone.*

**SITUATION 23 Rule 10.2 (j)**

*This will include any player who is outside or behind the imaginary line joining the top of the circles.*

**Rule 10.3 Falling on the Puck**

- (a) A Minor penalty shall be assessed any player except a goaltender, who deliberately falls on or gathers the puck into his body by any means, while standing or lying on the ice.
- (b) A Minor penalty shall be assessed any goaltender who, while outside his crease, deliberately falls on or gathers the puck into his body, or holds or places the puck against any part of the goal, thus delaying the game unnecessarily.
- (c) A Penalty Shot shall be awarded against the offending team when a defending player (except the goaltender) deliberately falls on the puck, holds or gathers the puck into his body in any manner, or picks up the puck with his hand, while the puck is within his goal crease. No other penalty shall be assessed.

*Note 1: If the goaltender has been removed from the ice, then a goal is awarded. See Rule 4.10 (b) Awarded Goals.*

*Note 2: This rule shall be interpreted so that a Penalty Shot will be awarded only when the puck is in the crease at the instant the offense occurs. However, in cases where*

*the puck is outside the crease, Rule 10.3 (a) may still apply and a Minor penalty may be imposed, even though no Penalty Shot is awarded.*

#### SITUATION 1 Rule 10.3 (c)

*The determining factor is the position of the puck at the moment when it is picked up or at the moment when the player intentionally falls on it.*

##### EXAMPLE 1:

*A player is in the crease, and the puck is outside the crease. The player holds or grabs the puck, pulling the puck into his body that is in the crease. Assess a Minor penalty for "Falling on the Puck", as the puck was outside the crease when the player grabbed the puck.*

##### EXAMPLE 2:

*A player who is outside the crease grabs the puck that is in the crease, pulling the puck outside the crease. Award a Penalty Shot, as the puck was in the crease originally when it was held or grabbed.*

##### EXAMPLE 3:

*The puck is to be considered "in the crease" when any part of the puck is in contact with the crease which includes the goal crease line.*

#### SITUATION 2

##### QUESTION:

*The goaltender has been removed and another player is lying in the goal crease. The puck is shot under him, but the player makes no attempt to cover, fall on or gather the puck into his body, however, the puck becomes frozen under his body. What is the ruling?*

##### ANSWER:

*No Penalty Shot or Minor penalty, provided that the player has made no deliberate attempt to cover the puck.*

*Note: See also Rule 10.1 (a) Note 3 – Delay of Game and Rule 4.10 (b) – Awarded Goals.*

#### SITUATION 3 Rule 10.3 (b)

*The intent of this rule is to eliminate unnecessary stoppages caused by the goaltender. The following guidelines should clarify the application of this rule.*

1. *A goaltender may freeze the puck in the goal crease when under pressure from attacking player(s).*
2. *The goaltender comes out of her crease to cut down the angle and after stopping the shot, covers the puck or catches the shot. This is legal.*
3. *Rule 9.1 (b), a Minor penalty shall be assessed to a goaltender who after one warning freezes the puck in the crease when not under pressure from attacking player(s).*
4. *The goaltender comes out of her crease to beat an attacking player to the puck and simply jumps on the puck, causing a stoppage of play. No warning shall be issued in this instance. A Minor for Delay of Game shall be assessed to the goaltender.*
5. *When a goaltender leaves her crease, she shall not be allowed to freeze the puck. No warning shall be issued. A minor penalty for Delay of Game shall be assessed to the goaltender.*

*Note: The overall intent of this rule is to keep the play going.*

**Rule 10.4 Goals and Assists**

- (a) A goal shall be scored when the entire puck has legally passed between the goal posts, below the cross bar and completely across the goal line. Following any goal, the Referee will resume play by conducting a face-off at the centre ice spot.
- (b) A goal shall be scored if the puck is put into the goal in any manner by a player of the defending team. The player of the attacking team who last played the puck shall be credited with the goal, but no assist shall be given.
- (c) A goal shall NOT be allowed if the puck has been directed into the net as a result of a distinct kicking motion by an attacking player, or after being kicked, the puck deflects off any player or stick into the net.
- (d) If the shot of an attacking player has been deflected into the goal by striking the stick, skates or any part of the body of an attacking player, the goal shall be allowed and the player off whom the puck deflected shall be credited with the goal and the player making the shot shall be credited with the assist. The goal shall not be allowed if the puck is deliberately directed into the net by any part of the body of an attacking player other than his skate.
- (e) If a goal is scored as the result of a puck deflecting directly into the goal off the person or skates of an official, the goal shall not be allowed.
- (f) Should a player propel the puck into the goal crease of the opposing team and the puck becomes loose and available to an attacking player, the puck shall be considered in the crease legally and any goal scored on this play shall be a legal goal.
- (g) Each goal and assist shall count one point in the scoring records. Not more than two assists shall be credited on any one goal.
- (h) Any goal scored, other than as covered by the Official Rules, shall not be allowed. The resulting face-off shall be determined as per Rule 10.2 (e), (f) & (i).

**SITUATION 1 Rule 10.4 (a)**

*A goal is scored at the end of the second period (0:01) and the buzzer sounds to end the period (the goal was scored before the buzzer sounds and the Referee allows the goal to count). It is not necessary for the Referee to conduct a face-off at centre ice. In such case, the Referee should ensure that the Timekeeper records the goal at 0:01 on the Official Game Report.*

**SITUATION 2**

*Team "A" No. 2 has been assessed a Minor penalty at 2:00 and Team "A" No. 6 has been assessed a Minor penalty at 1:15. As in Situation 1, Team "B" scores at 0:01, with the buzzer sounding to end the period.*

**RULING:**

*Even though it is not necessary to conduct the face-off and even though the period is over, the goal is registered at 0:01. Accordingly, the penalty to Team "A" No. 2 would be washed out and No. 6 would still have to serve the time remaining in his penalty.*

**SITUATION 3**

*A goal is scored. On checking, the Referee is notified that the clock had stopped and was not running when the goal was scored.*

**RULING:**

*Providing the time of the period was not over, the goal shall count. The Referee in discussion with the Linesman and Timekeeper should try to determine what length of time the clock*

was not running, then make the necessary adjustments. If neither the Referee, Linesman, or Off-ice officials can determine this adjustment, then the game should continue using the time on the clock.

**SITUATION 4 Rule 10.4 (e)**

The puck is shot by either an attacking or defending player and hits an official. After hitting the official, the puck hits the boards then rebounds into the goal.

**RULING:**  
Goal.

**SITUATION 5 Rule 10.4 (f)**

An attacking player is standing in the goal crease. The puck is shot, hitting the player in the crease, and drops down in the crease. The attacking player gets out of the crease, then shoots the puck into the goal.

**RULING:**  
GOAL. The puck did not enter the goal while the attacking player was actually in the crease.

**SITUATION 6 Rule 10.4 (f)**

A goaltender is out of his crease and a player of the opposing team who is standing in the crease, pulls the puck into the crease and then shoots it into the goal.

**RULING:**  
NO GOAL. The player was in the goal crease before the puck and remained in the crease while the puck entered the goal. Therefore the goal is not allowed.

**SITUATION 7**

No goal is to be allowed if the goal is off its mooring, regardless of whether or not the goal may have been deliberately knocked from its mooring, except under Rule 4.9 (b) - Penalty Shot, when the goaltender has deliberately dislodged the goal from its mooring during a Penalty Shot or again under Rule 4.10 (b) - Awarded Goals, when the goaltender has been removed and he or any teammate has deliberately dislodged the goal from its mooring and such action has prevented a goal from being scored.

**SITUATION 8**

A puck is shot; it hits a helmet, stick or other object on the ice and goes into the goal.

**RULING:**  
GOAL.

**SITUATION 9 Rule 10.4 (g)**

Goals which have been awarded, scored from Penalty Shots or scored by the defending team into their own net shall be recorded as unassisted goals.

**SITUATION 10**

Team "A" shoots the puck at the goal of Team "B". The puck enters the net but immediately bounces out again without the Referee seeing the goal. The Referee suspects there may have been a goal scored but allows play to continue. At the first stoppage of play the Referee checks with his Linesmen and Goal Judge (if appropriate). At least one of them saw the puck enter the net and the Referee awards a goal to Team "A".

**QUESTION 1:**  
Should the Linesman who saw the puck enter the net have blown the play immediately?

**ANSWER:**

*No, the Linesman must wait for the first stoppage of play and report what he saw to the Referee who may then award the goal.*

**QUESTION 2:**

*Should the clock be reset to the time the goal was scored (or as near as can be estimated by the officials)?*

**ANSWER:**

*The clock should be reset if at all possible. Especially if the next stoppage of play happens to be the end of the period.*

**QUESTION 3:**

*If Team "B" had scored before the play was stopped, would the Team "B" goal count?*

**ANSWER:**

*No, the Team "B" goal would not count as the play should have been stopped when Team "A" scored.*

**SITUATION 11 Rule 10.4 (c)**

*If an attacking player kicks the puck and it is deflected into the goal by any player (attacking or defending) or goalkeeper, the goal shall NOT be allowed. See Rule 10.7.*

**Rule 10.5 Icing the Puck**

- (a) Icing the puck is completed the instant the puck crosses the goal line, and the Referee or Linesman shall immediately blow her whistle, stopping play. If the puck shall have entered the goal, the icing shall not be called and a goal shall be allowed.

For the purpose of this rule, the centre red line will divide the ice into halves. Should any player of a team, equal or superior in numerical strength to the opposing team, shoot, "bat" or deflect the puck from her own half of the ice, beyond the goal line of the opposing team, play shall be stopped and the puck faced-off at the end zone face-off spot of the offending team.

If during the play, the puck shall have entered the net of the opposing team, the goal shall be allowed, except if the puck has been batted with the hand into the opposing net. Any contact with the puck over the centre red line, with the puck continuing down over the goal line, nullifies "icing" the puck.

*Note 1: If during the period of a delayed whistle due to a foul by a player of the side NOT in possession of the puck, the side in possession "ices" the puck, the face-off following the stoppage of play shall take place in the neutral zone near the defending team blue line of the team "icing" the puck.*

*Note 2: A team shall not be considered below the numerical strength of its opponent by reason of a penalized player remaining in the penalty box after her penalty has expired.*

*Note 3: When the puck is shot and rebounds from the body or stick of an opponent in her own half of the ice and crosses the goal line of the player shooting, it shall NOT be considered as "icing".*

- (b) "Icing the puck" shall not be called if a team is below the numerical strength of the opposing team at the instant the puck is shot.
- (c) Play shall continue and the "icing the puck" infraction shall not be called if it is caused directly from either player taking the face-off.

- (d) If, in the opinion of the Referee or Linesmen, a player of the opposing team, except the goaltender, is able to play the puck before it crosses the goal line, but has not done so, the play shall continue and the “icing the puck” rule shall not apply.
- (e) The “icing the puck” infraction shall not be called and play shall continue when:
  - (1) the puck has touched any part of an opposing player, her stick, or skates, or
  - (2) the puck has touched the goaltender, her skates, or stick at any time before crossing the goal line.
- (f) If the Referee or Linesmen shall have erred in calling an “icing the puck” infraction under any conditions, the face-off shall take place at the centre ice face-off spot.

**SITUATION 1 Rule 10.5 (a)**

*The puck is shot by a player behind her blue line, hits a teammate's body or stick behind the centre red line, then goes down over the goal line. ICING.*

**SITUATION 2 Rule 10.5 (a)**

*The puck is passed from behind the blue line to a teammate who is standing with both skates back of the centre red line. The puck hits the stick of that player, which is over the centre red line, then goes down over the opponents' goal line. NO ICING.*

**SITUATION 3 Rule 10.5 (a)**

*The puck is passed from behind the blue line to a teammate standing with one skate either over or back of the centre red line. The puck hits the teammate's stick which is over the centre red line, then goes down over the opponent's goal line. NO ICING.*

**SITUATION 4 Rule 10.5 (a) Note 3**

*The puck is shot by an attacking player and hits a defending player who is back of the centre red line. The puck, after hitting the defending player, then goes down over the goal line of the player shooting the puck. NO ICING.*

**SITUATION 5**

*A player standing with both skates back of the centre red line and the puck on her stick over the centre red line, shoots the puck down over the goal line. NO ICING.*

**SITUATION 6**

*A player standing with one skate on the centre red line and one skate over or back of the centre red line and the puck on her stick over the centre red line, shoots the puck down over the goal line. NO ICING.*

**SITUATION 7 Rule 10.5 (a)**

*The puck is shot by a player who is over the blue line to a teammate who is over the centre red line. The puck hits the latter players' body or stick and goes down over the goal line. NO ICING.*

**SITUATION 8 Rule 10.5 (a)**

*The puck is passed by a player standing with both skates back of her blue line and the puck on her stick over the blue line. The puck hits a teammate's stick or skates that are over the centre red line, then deflects down over the opposing goal line. NO ICING.*

**SITUATION 9 Rule 10.5 (e)(2)**

*The puck is shot by a player standing behind the centre red line. The puck goes down the ice through the goal crease and then over the goal line. ICING.*



**SITUATION 10 Rule 10.5 (a)**

*The puck is shot by a player from Team "A" in her half of the ice surface. It deflects off any player of either team before crossing the goal line. NO ICING.*

**SITUATION 11**

*The puck which is sitting on the centre red line is shot down over the goal line. It is ICING if the stick was still in contact with the centre red line when the puck was shot. It is NOT ICING if the stick is over the centre red line when the puck leaves the stick.*

**SITUATION 12 Rule 10.5 (a)****QUESTION:**

*At which end zone face-off spot does the face-off take place following an icing?*

**ANSWER:**

*The face-off takes place at the face-off spot on the side of the ice from which the puck was shot.*

**SITUATION 13 Rule 10.5 (b)**

*When the time of a penalty is up, the Off-ice Official should open the gate of the penalty bench. If an icing situation is involved, as soon as the gate is opened, the player is considered to have completed her penalty and is on the ice, for the purpose of equal numbers (or not).*

**SITUATION 14**

*If a puck shot by a teammate is contacted by a high stick but still continues on over the goal line for a potential icing and no player of the non-offending team touches the puck, then call ICING as soon as the puck crosses the goal line.*

**SITUATION 15 Rule 10.5 (b)**

*Where a penalty is being served which makes a team short-handed, and that team shoots the puck from behind the centre red line down over the opponents' goal line, NO ICING will be called and play shall be allowed to continue unless the penalty terminates before the puck is shot. If the team returns to full strength following the shot by one of its players, NO ICING can be called. The determining factor is based on the numerical strength at the instant the puck is shot.*

**SITUATION 16****QUESTION:**

*The puck is shot by a player behind her blue line. A potential icing is signaled by the back Linesman. An opposing team player is within 10 feet of her players' bench and her substitute comes onto the ice as the puck passes within reach of these two players. Playing the puck would constitute a Bench Minor penalty for too many men. The opposing players make no attempt to play the puck in this situation, with the puck continuing on down over the goal line. Is icing called or is it waved off because the opposing player could have played the puck?*

**ANSWER:**

*NO ICING. The team shooting the puck should not be penalized because a line change was being made.*

**SITUATION 17**

*Team "A" ices the puck, the goaltender from Team "B" comes out of his crease to potentially play the puck. The goaltender does not play the puck. Ruling - Icing. If the goaltender prevents an attacking player from a significant potential to nullify the icing, the icing shall*

*be waved off. If the goaltender causes significant interference then a Minor penalty would also be assessed.*

#### SITUATION 18

*Team A shoots the puck from their defending zone down the ice. The puck deflects off a Team B player then deflects off a Team A player prior to crossing the centre red-line.*

*The puck then goes down the ice crossing the goal line, meeting all the criteria of icing.*

**RULING:**

*Icing*

### Rule 10.6 Interference by Spectators

- (a) The Referee shall stop play if a player is being held or interfered with by a spectator, unless that player's team is in possession of the puck and in scoring position at the time. In this case, play shall be allowed to be completed before the stoppage. In any case, the face-off shall be where the stoppage took place, unless otherwise stated in the rules.
- (b) The Referee shall stop play if any objects are thrown on the playing surface which interfere with the progress of the play. When the play resumes, the face-off shall be where the stoppage took place, unless otherwise stated in the rules.

### Rule 10.7 Kicking the Puck

- (a) Kicking the puck shall be permitted in all zones. This action can not result in a goal being scored.

#### **NEW (b) No goal can be scored when an attacking player kicks another object which, in turn, propels the puck directly or indirectly into the goal.**

#### SITUATION 1

*If an attacking player kicks the puck and it is deflected into the goal by any player (attacking or defending) or goalkeeper the goal shall NOT be allowed. See Rule 10.4. The key principle of this rule is that no goal can be scored when an attacking player kicks the puck or other object, which in turn propels the puck, unless the puck is subsequently clearly "shot" into the goal by a clear shooting motion. After any kicked puck, the official should watch closely for a clear shooting action and if the puck enters the goal and no clear shooting action was observed, then the official must disallow the goal. The subsequent face-off after the above stoppage of play shall be in the neutral zone.*

*To further clarify: Any attacking player that kicks a puck to a teammate and: - it deflects off the teammate's skate, body or stick - no goal. - if it is deliberately directed into the goal by a teammate's stick, but not clearly shot - no goal. - if it is deflected or deliberately directed (but not kicked) into the goal by a teammate's skate - no goal. - if it is kicked by an attacking player, and then deflects off his own stick into the goal - no goal.*

### Rule 10.8 Off-sides

- (a) Players of the attacking team must not precede the puck into the attacking zone.

*Note 1: If a pass deflects off a defending player, his skates or his stick, causing an attacking player to precede the puck into the attacking zone, the off-side rule shall apply.*

*Note 2: A player actually propelling the puck who shall cross the line ahead of the puck, shall not be considered off-side, providing he is actually in possession and control of the puck with one skate in the neutral zone before crossing the blue line.*

- (b) For violation of this rule, play shall be stopped and the face-off shall be in the neutral zone at the face-off spot nearest the attacking zone of the offending team or at the origin of the attempted pass, as covered by the rules.
- (c) The position of the player's skates, and not that of his stick, shall be the determining factor in all instances in deciding an "off-side".

A player is off-side when both skates are completely over the outer edge of the blue line involved in the play.

*Note 1: A player is on-side when either of his skates are in physical contact with, or on his own side of the line at the instant the puck completely crosses the outer edge of that line, regardless of the position of his stick.*

*Note 2: It should be noted that while the position of the player's skates is what determines whether a player is off-side, the question of an off-side never arises until the puck has completely crossed the outer edge of the line at which the decision is to be made.*

- (d) If a player legally carries or passes the puck from the neutral zone back into his own defending zone while a player of the opposing team is in such defending zone, the off-side shall be ignored and play shall continue.
- (e) If an attacking player(s) precedes the puck that is shot, passed or deflected into the attacking zone by a teammate, or deflected into the attacking zone by a defending player; but a defending player is able to play the puck, the Linesman shall signal a delayed off-side.

The Linesman shall drop his arm to nullify the off-side violation and allow play to continue if:

- (1) the defending team passes or carries the puck into the neutral zone, or
- (2) all attacking players in the attacking zone (at the time the puck crosses the blue line) clear the attacking zone by making skate contact with the blue line. If the puck is shot on goal, during a delayed off-side, the play shall be allowed to continue under the normal clearing the zone rules. Should the puck enter the net in this situation, either directly or off the goaltender, or a player or official on the ice, the goal shall not be allowed as the original shot was off-side. If any attacking player touches the puck or attempts to gain possession of a loose puck while the puck is still in the attacking zone, the Linesman shall stop play.

*Note: The attacking zone must be completely clear of attacking players before a delayed off-side can be nullified with the puck still in the attacking zone.*

- (f) If, in the opinion of the Referee or Linesmen, an intentional off-side play has been made, the puck shall be faced-off at the end zone face-off spot in the defending zone of the offending team.

#### SITUATION 1

*A player has one skate on the blue line and one skate over the blue line at the instant the puck completely crosses the blue line. NO OFF-SIDE.*

**SITUATION 2**

*A player has both skates back of the blue line and their stick over the blue line at the instant that the puck completely crosses the blue line. NO OFF-SIDE.*

**SITUATION 3**

*A player has one skate above the blue line (over top, but not touching) and one skate over the blue line at the instant the puck completely crosses the blue line. OFF-SIDE.*

**SITUATION 4**

*A player has one skate back of the blue line and one skate over the blue line at the instant that the puck completely crosses the blue line. NO OFF-SIDE.*

**SITUATION 5**

*A player has both skates over the blue line, but the puck is still on the blue line. Potential OFF-SIDE but, not until the puck completely crosses the blue line.*

**SITUATION 6 Rule 10.8 (a) Note 2**

*This is intended to mean that one skate should be touching the blue line or in the neutral zone with the player having possession and control of the puck before preceding and propelling the puck into the attacking zone.*

**SITUATION 7 Rule 10.8 (a) Note 2 & 10.8 (a)**

*A player with both skates over the blue line receives a pass from a teammate. He stops the puck with his stick before the puck crosses the line, then pulls it over the line. OFF-SIDE - the player must have control of the puck with one foot touching the blue line or in the neutral zone, for the propelling the puck rule to be applicable. If this player then comes back, puts one skate on the blue line, he may then precede and propel the puck into the attacking zone.*

**SITUATION 8 Rule 10.8 (a) Note 1**

*An attacking player has both skates over the blue line. A teammate in the neutral zone shoots the puck. The puck hits an opponent, deflecting off his body or stick, then the puck crosses the blue line. DELAYED OFF-SIDE.*

**SITUATION 9 Rule 10.8 (d)**

*An attacking player has both skates over the blue line. An opposing player has possession of the puck in the neutral zone. This player now shoots or passes the puck back into his defending zone while the attacking player is still in the zone. NO OFF-SIDE.*

**SITUATION 10**

*The puck is in the possession of the attacking team in the attacking zone. The puck is passed back to the blue line. The puck comes half-out over the blue line (half on the line and half over the line) then is shot deep in the zone again. NO OFF-SIDE.*

**SITUATION 11**

*An attacking player crosses the blue line with the puck. He then brings the puck on his stick back out over the blue line into the neutral zone while his skates are still in the attacking zone and then brings the puck back again into the attacking zone. OFF-SIDE. For the player to remain on-side he must place one foot on the blue line or in the neutral zone before preceding and propelling the puck into the attacking zone.*

## SITUATION 12

*An attacking player or defending player in the attacking zone shoots the puck out over the blue line. The attacking player or players must come back, put one skate (at least) on the blue line and keep the skate on the line until the puck completely crosses the line again. NO OFF-SIDE will then be the call.*

## SITUATION 13 Rule 10.8 (a) Note 1

*A defending player shoots the puck out over his defending blue line. It then deflects off another defending player back into his defending zone while an attacking player is in that zone. DELAYED OFF-SIDE.*

## SITUATION 14 Rule 10.8 (a) Note 2

*An attacking player straddling the attacking blue line, takes a pass on his stick in the neutral zone. He then brings the skate which was in the neutral zone over the line while the puck is still on his stick in the neutral zone. He then pulls the puck over the blue line. NO OFF-SIDE.*

## SITUATION 15

*A player has one skate over the blue line and one skate back of the blue line in the neutral zone. The skate in the neutral zone is in the air and not on the ice at the instant the puck crosses the blue line. OFF-SIDE.*

## SITUATION 16

## QUESTION:

*A player lying on the ice has the boot of his skate on the ice. Does it have to be the blade of the skate on the ice for these off-side situations?*

## ANSWER:

*No - skate means blade or boot.*

## SITUATION 17 Rule 10.8 (b)

*An attacking player or defending player in the attacking zone shoots the puck back over the blue line into the neutral zone. The puck hits an official in the neutral zone and deflects off the official back over the blue line while an attacking player is still in the attacking zone. DELAYED OFF-SIDE.*

## SITUATION 18

## QUESTION:

*The puck is shot by a player from behind the centre red line. A teammate precedes the puck across the attacking blue line. The Linesman signals a delayed off-side. The back Linesman is signaling a potential icing. The puck continues on down the ice crossing the goal line. Assuming the attacking player did not clear the zone, which infraction is called, off-side or icing?*

## ANSWER:

*Icing.*

## SITUATION 19

*For off-sides, the face-off should take place on the side of the ice closest to where the puck crossed over the blue line. This refers to situations where the puck is carried into the attacking zone causing an off-side.*

## SITUATION 20

*When a penalty is over, the Penalty Timekeeper should open the penalty box door. Even though the player coming out of the box would be off-side, the fact that he may wait until the puck crosses the blue line to come on the ice would not change the fact that he is still off-side. As soon as the Penalty Timekeeper opens the penalty box door, the player is considered on the ice.*

## SITUATION 21

*When a player comes on the ice from either the players' or penalty bench in his attacking zone, thereby preceding the puck in his attacking zone, the off-side will apply. Should the puck cross the blue line before the player actually gets on the ice, the play shall be legal and no off-side shall be called. As explained in Situation 20 of this rule, in the case of a player getting on the ice after serving a penalty, such player shall not be entitled to wait in the penalty box until the puck has crossed the blue line. Once his time has expired, the player shall be considered on the ice for the purpose of this rule.*

## GUIDELINES FOR DELAYED OFF-SIDE SITUATIONS

1. *The attacking zone must be completely clear of all players before the off-side is nullified.*
2. *An attacking player in the attacking zone cannot come out and make skate contact with the blue line and go back into that zone while a teammate is still there and the delayed off-side still in effect.*
3. *Attacking players who were not off-side when the delayed off-side went into effect must wait until the delayed off-side is nullified before they can go into their attacking zone.*
4. *If the puck is shot from behind the center red line (an icing situation) with attacking players in their attacking zone, and the puck is not able to be played by a defending player before it crosses the goal line, then the icing call would be made in lieu of the off-side.*
5. *If the play is stopped because of the off-side, the ensuing face-off would go to the spot where the shot originated in accordance with Rule 10.2 (g).*

## SITUATION 22

*No goal may be scored on a delayed off-side by the offending team while the delayed off-side is still in effect, unless the defending team shoots or puts the puck in their own net without action or contact by the offending team (as in a delayed penalty situation).*

## QUESTION:

*A team shoots the puck in the direction of the goal and the delayed off-side goes into effect (the Linesman raises his arm) but before the puck gets to the goal, the offending team clears the zone and the Linesman drops his arm. When the puck enters the goal the Linesman's arm is down. Does the goal count?*

## ANSWER:

*No.*

## SITUATION 23 Rule 10.8 (f)

*For the purpose of this rule the following guidelines apply when determining an "Intentional Off-side". The play shall be considered an "Intentional Off-side" when:*

1. *A player deliberately plays the puck in a delayed off-side situation, knowing that he is off-side.*

2. A player deliberately carries the puck into the attacking zone when he knows that players from his team are in an off-side position. When this occurs, play shall be stopped immediately, and the puck shall be faced-off at the end zone face-off spot, in the defending zone of the offending team.

#### SITUATION 24

A delayed off-side is signaled by the Linesman. Attacking players A5 and A8 leave the attacking zone into the neutral zone ("tagging up"). Attacking player A10 leaves the ice inside the attacking zone, and goes into his players' bench. The puck is still in the attacking zone.

#### QUESTION:

What does the Linesman do?

#### ANSWER:

The Linesman would drop his arm thereby nullifying the delayed off-side provided that the substitute for player A10 does not enter the attacking zone until such time as the delayed offside has been nullified (the instant the zone is completely free of attacking players). If the substituting player enters the zone before the Linesman lowers his arm, the delayed off-side would remain in effect.

### Rule 10.9 Passes

- (a) A pass shall be considered to have been completed if the puck so passed contacts any part of the stick, body or skate of the player on the same team.
- (b) If an attacking player passes the puck backwards towards her own goal from the attacking zone, an opponent may play the puck regardless of whether or not she (the opponent) was in the same zone at the time the puck was passed.
- (c) A player in his own defending zone may make a pass to a player of the same team, anywhere in the neutral zone.

### Rule 10.10 Puck Must Be Kept in Motion

A Minor penalty shall be assessed any player who deliberately holds the puck against the boards or any part of the goal in any manner, unless he is being checked by an opponent.

*Note: Referees must determine the offending player and enforce these rules quickly.*

#### SITUATION 1

Team A is already shorthanded when another delayed penalty is signaled against Team A. Team B, wishing to have a stoppage of play, pushes the puck towards a Team A player who refuses to play the puck. The Referee shall not stop the play as the defending Team A is not in violation of this rule.

### Rule 10.11 Puck Out of Bounds or Unplayable

- (a) When the puck goes outside the playing area or strikes obstacles above the playing surface (with the exception of the side boards, glass or wire netting), play shall be stopped. The resulting face-off shall be where the puck last touched a player, her skates or stick, or an official, except when otherwise stated in the rules.
- (b) A Minor penalty shall be assessed any player who delays the game by deliberately shooting, batting or throwing the puck outside the playing surface of the rink. The

resulting face-off shall be at the spot where the offense occurred, unless otherwise stated in the rules.

- (c) If the puck is shot on the back of the net and comes off without any delay or, if a player or goaltender knocks the puck off the back of the goal netting without unnecessary delay, play shall continue. If the puck is frozen between opposing players or cannot be removed from the back of the net, the Referee shall stop play and the face-off shall take place at a location covered by the rules.

*Note: Existing rules are adequate to deal with the situation regarding play in the attacking zone, but officials should be alerted to move the face-off into the neutral zone in every case where it is the action of the attacking players which has caused the stoppage, even though they may not be actually freezing the puck themselves.*

- (d) A Minor penalty shall be assessed a goaltender who deliberately drops or throws the puck on the goal netting to cause a stoppage of play.

#### SITUATION 1

##### QUESTION:

*An attacking player shoots the puck on the back of the opponents' net, from inside the attacking zone.*

##### ANSWER:

*The face-off would take place at the nearest face-off spot in the neutral zone.*

##### QUESTION:

*An attacking player anywhere in the neutral zone shoots the puck into the attacking zone and on the back of the opponents' net. Where does the face-off take place?*

##### ANSWER:

*The face-off would take place in the neutral zone at the point from where the puck was shot, in accordance with Rule 10.2 (g).*

*Note: This interpretation also includes the situation where a team is short-handed and a player in his defending zone shoots the puck down the ice over the opponents' goal line, with the puck hitting the end boards and ending up on the back of the opposing goal net. In this case, the face-off would take place in the defending zone of the team shooting the puck at the point of origin of the shot, unless otherwise covered by the rules.*

#### SITUATION 2 Rule 10.11 (a)

##### QUESTION:

*The puck is shot by an attacking player in the attacking zone, deflects off the goalpost and goes out of bounds. Where does the face-off take place?*

##### ANSWER:

*The face-off would take place in the neutral zone in accordance with Rule 10.2 (g).*

#### SITUATION 3 Rule 10.11 (c)

*The puck is shot from behind the net and goes under the base plate or through the goal netting to a position in front of the net. In this case play shall be stopped and the face-off shall take place at a spot covered by the rules.*

#### SITUATION 4 Rule 10.11 (c)

*If the puck becomes lodged on the back of the net, players are now given an opportunity to play the puck off the net. Quite often, the goaltender, a defencemen or an attacking player can do this without delay. This is an acceptable practice. However, if this is not possible given a reasonable opportunity, the Referee should stop play.*



**Rule 10.12 Puck Out of Sight and Illegal Puck**

- (a) At any time where the Referee loses sight of the puck, play shall be stopped. The resulting face-off shall be at the point where play was stopped, unless otherwise stated in the rules.
- (b) If while play is in progress a puck other than the one legally in play appears, the play shall not be stopped, but shall continue with the legal puck until the play then in progress is completed.

**SITUATION 1 Rule 10.12 (b)**

*Where a second puck appears on the ice, allow play to be completed if the second puck in no way affects the legal puck. Stop play when the play has been completed, unless one of the officials picks up the second puck.*

*Note 1: When possible, officials should make every attempt to pick up the second puck in order that play may continue.*

*Note 2: If a player deliberately shoots the second puck at an opposing player in possession and control of the legal puck, assess a Minor penalty for interference under Rule 7.3. If the player in possession and control of the legal puck is on a breakaway in the attacking or neutral zone and the second puck is shot at him, this gesture shall be considered as fouling from behind and Rule 7.4 (d) - Tripping, shall apply, meaning that a Penalty Shot shall be awarded against the offending team if the player on the breakaway in the neutral or attacking zone was prevented from having a clear shot on goal.*

**Rule 10.13 Puck Striking Official**

Play shall not be stopped if the puck touches an official anywhere on the rink, except when the puck is deflected directly off an official into the goal or out of the playing area.

**Rule 10.14 Refusing to Start Play**

- (a) If a team is withdrawn from the ice and fails to return and start play, or if being on the ice, fails to start play within TWO MINUTES after being ordered to do so by the Referee, the game or series shall be suspended. The team officials and/or players of the team which are responsible for any of these actions may be suspended for one year or more from the date of the infraction. The Referee shall report full details of the incident to the President. If a team after being ordered to return, does return to start play, then a Major penalty and a Game Misconduct shall be assessed to the Coach for Delay of Game. If this infraction occurs in the last two minutes of regular playing time, or anytime in overtime, a Penalty Shot (in addition to the Major penalty and a Game Misconduct) shall be awarded against the offending team's coach, as stated in Rule 10.1 (e) - Delay of Game.
- (b) The commencement of the two-minute warning and the reason for such warning shall be announced over the public address system, on the instructions of the Referee.
- (c) If a team is withdrawn from the ice or fails to go on the ice, or being on the ice, fails to start play a SECOND TIME within the same game after being ordered to do so by the Referee, the two-minute allowance shall not be granted and the game will be officially suspended. The team officials and/or players of the team which are responsible for any of these actions may be suspended for one year or more from the date of the infraction. The Referee shall report full details of the incident to the President.

*Note: Should the offending team be on the ice surface, the order shall be given in person by the Referee or the Linesman, if directed by the Referee. If the offending team is not on the ice, the Timekeeper, on the instruction of the Referee, will convey the order to the offending team. The order may be given to any player or team official of the offending team.*

- (d) If a team fails to present itself at the time and place appointed to play any game, the game shall be awarded to the opposing team, unless such failure is caused by an unavoidable accident or unforeseen contingency.

The team official and/or players responsible for any of these actions shall be reported to the President by the Referee, giving full details of the incident.

- (e) A player or team official who refuses to leave the bench or playing area after he has been assessed a Game Misconduct penalty, Gross Misconduct or Match penalty, TWO MINUTES AFTER BEING ORDERED TO DO SO BY THE REFEREE, the game or series shall be suspended. The team officials and/or players of the teams which are responsible for any of these actions may be suspended for one year or more from the date of the infraction. The Referee shall report full details of the incident to the president. IF THE PLAYER OR TEAM OFFICIAL AFTER BEING ORDERED TO LEAVE, DOES LEAVE THE BENCH OR THE ICE, then a Major penalty and a Game Misconduct shall be assessed to the Coach for Delay of Game. If this infraction occurs in the last two minutes of regular playing time, or anytime in overtime, a Penalty Shot (in addition to the Major Penalty and a Game Misconduct) shall be awarded against the offending team's, as stated in Rule 10.1 (e) – Delay of Game.

### **Rule 10.15 Start of Game and Periods**

- (a) The game shall commence at the time scheduled by a face-off in the centre of the rink. It shall be renewed promptly at the conclusion of each intermission in the same manner. No delay shall be permitted by reason of any ceremony, exhibition, demonstration or presentation, unless consented to reasonably in advance by the Visiting Team.
- (b) To start the game, at the beginning of each period (including any overtime periods) and following the scoring of a goal, the Referee shall conduct a face-off at the centre ice spot.
- (c) Home teams shall have the choice of goals to defend at the start of the game. See Rule 1.9 (e).
- (d) At the beginning of each period, only the players taking part in the actual face-off shall be allowed on the ice. All other players not taking part in the face-off shall go directly to their benches. For an infraction of this rule, a Bench Minor penalty for delay of game shall be assessed the offending team.

#### **SITUATION 1 Rule 10.15 (d)**

*This section would not apply when teams come on the ice for their pre-game warm-up and stay on the ice for the start of the game (no ice flooding after the warm-up period). The Referee would simply blow her whistle and the players would then go to their benches. Likewise, do not apply the rule during the time lapse between the end of the third period and the start of the first overtime period, unless the teams leave the ice and go to their dressing rooms. When there is a flood between the pre-game warm-up and the actual start of the game or where a team leaves the ice prior to the start of the game, apply the rule.*

**SITUATION 2 Rule 10.15 (d)**

*Where this rule is applied at the beginning of a period, this entails that NO player change can take place before the puck is dropped to start the period. The players on the ice must be the ones starting the period, unless a penalty is assessed at that time which will make a team short-handed.*

**Rule 10.16 Tied Game**

- (a) If at the end of the three regulation twenty-minute periods the score is tied, the following shall take place:
  - (1) if the Referee feels it is necessary, he may order the ice to be re-surfaced at the end of the three regulation periods. If the ice is not resurfaced, the teams will not change ends;
  - (2) the puck shall be faced-off at centre ice and the play shall continue with a ten-minute sudden victory overtime period;
  - (3) if the score is still tied after the sudden victory ten minute overtime period, the teams would take the normal between period break and return to play twenty minute sudden victory periods. The teams will now change ends.
- (b) Any overtime period shall be considered part of the game and all unexpired penalties shall remain in force.
- (c) If either team declines to play in the necessary overtime period or periods, the game shall be declared a loss for that team.

*Note: Branches and Leagues may make their own rules regarding overtime for games under their jurisdiction.*

**Rule 10.17 Time of Game**

- (a) Three twenty minute periods of actual playing time with a ten-minute intermission between each period, will be the time allowed for each game.
- (b) The team scoring the greatest number of goals during the three twenty-minute periods shall be the winner and shall be credited with two points in the league standing.
- (c) Teams shall change ends after the completion of each regulation period and each overtime period (except as stated in Rule 10.16 (a)(1)).
- (d) In the interval between periods, the ice surface shall be flooded, unless mutually agreed to by the competing clubs or unless the facilities are not available.
- (e) If any unusual delay occurs within five minutes before the end of the first or second period, the Referee may order the next regular intermission to be taken immediately. The balance of the period will be completed on the resumption of play with the teams defending the same goals, after which the teams will change ends and resume play of the ensuing period without delay.
- (f) Each team shall be permitted to take one time-out of thirty seconds during the course of regular playing time or overtime. This time-out must be taken during a normal stoppage of play. Any player designated by the Coach may indicate to the Referee that his team is exercising their option and the Referee will report the time-out to the Game Timekeeper who shall be responsible for signalling the termination of the time-out.

*Note 1: All players, including goaltenders, on the ice at the time of the time-out will be allowed to go to their respective benches.*

*Note 2: Both teams may take their respective time-outs during the same stoppage of play. However, once a team has called their time-out, the second team must indicate their intentions to take a time-out during the same stoppage of play before the initial 30 seconds are over.*

*Note 3: The time-out rule is permitted in Minor and Female Hockey stop time games wherever the local branch gives approval. In Hockey Canada Minor and Female Hockey Regional and National Championships, the time-out rule is to be used.*

**SITUATION 1** Rule 10.17 (f)

**TIME-OUT GUIDELINES**

1. Each team may have one thirty second time-out per game. This includes any overtime.
2. Both teams may take their time-out during the same stoppage of play.
3. All players including goaltenders may go to their respective benches during the time-out.
4. The Referee must advise the Timekeeper of the time-out and the Timekeeper will indicate when the time-out is over.

**NEW 5. The Referee should allow the calling of a time-out at a stoppage of play, at any time up to the point of dropping the puck for a face-off.**

6. Subsequent to the time-out, the line change procedure shall recommence.

**MINOR AND FEMALE HOCKEY SUPPLEMENT**

The following rules apply only to Minor and Female Hockey.

**Rule 2.2 Players in Uniform**

- (a) Each team shall be entitled to a maximum of 19 (Jr. A, B, Senior (male and female) and AAA Midget - 20) players in uniform, (which includes two goaltenders, for any game or pre-game warm-up, all of whom shall be duly registered in accordance with Hockey Canada Regulations.

**Rule 2.6 Injured Players**

- (c) Goaltender replacement shall be subject to the rules governing goaltenders and be allowed the goaltender's full equipment. In Divisions of Pee Wee and below, after a player has been designated as a goaltender, he/she may return to a non-goaltender position. Only in Divisions above Pee Wee, the player must remain as a goaltender once they have been designated as such.

**Rule 3.6 Protective Equipment**

- (f) The wearing of a BNQ approved throat protector is compulsory for players registered in minor and female hockey. When a player fails to wear or properly wear a throat protector at any time on the ice during the game, the team shall receive one warning and any subsequent infractions by the same team will result in a Misconduct. Referees are encouraged to deliver this warning directly to the coach.

**Rule 4.6 Game Ejection/Game Misconduct Penalties**

- (c) Any player or team official who is assessed a Game Misconduct penalty in the last ten minutes of regular time, **at** any time in overtime, or **after** the conclusion of the game and prior to the player or team official entering his dressing room, shall automatically be suspended for a minimum of the next regular league/play-off game or seven days.

**Rule 4.7 Gross Misconduct Penalties**

- (c) Any player or team official who is assessed a Gross Misconduct penalty in the last ten minutes of regular time, **at** any time in overtime, or **after** the conclusion of the game and prior to the player or team official entering his dressing room, shall automatically be suspended for a minimum of the next regular league/play-off game or seven days.

**Rule 5.1 Appointment of Officials**

- (f) For inter-branch play-off games, only Level V & VI certified Referees shall be appointed, but for National Championships and designated I.I.H.F. competition, the Referee shall be a certified Level VI Referee. This does not necessarily apply to Minor and Female Hockey.

**Rule 6.2 Boarding and Body Checking**

- (b) In divisions of Atom and below and Female Hockey, a Minor penalty or, at the discretion of the Referee, a Major penalty and a Game Misconduct penalty shall be assessed any player who, in the opinion of the Referee, intentionally body checks, bumps, shoves or pushes any opposing player. If a player is injured, a Major penalty and a Game Misconduct penalty must be assessed.

When the offensive player is skating towards the defensive player, the defending player may not hit the offensive player by going in the opposite direction to that player. The body contact must be as a result of the movement of the offensive player. There must be no action where the offensive player is pushed, checked or shoved into the boards. Where, in the opinion of the Referee, accidental contact has taken place, no penalty shall be assessed.

**Rule 10.17 Time of Game**

- (f) (Note 3): The time-out rule is permitted in Minor and Female Hockey stop time games wherever the local branch gives approval. In Hockey Canada Minor and Female Hockey Regional and National Championships, the time-out rule is to be used.

**OPTIONAL RULES FOR JUNIOR AND SENIOR HOCKEY**

The following optional rules may apply only to Junior and Senior Hockey Leagues that have received Branch approval. Those leagues must obtain appropriate Hockey Canada insurance. Leagues adopting these optional rules must revert to regular Hockey Canada playing rules for all inter-branch play-offs.

**Rule 6.1 Attempt to Injure or Deliberate Injury**

A Minor penalty for slashing will be imposed on a player who jabs the back of another players leg with the spear end of his blade, or who uses the spear end of his blade in any manner which in the Referee's opinion does not warrant a double Minor penalty or Match penalty for spearing.

**APPENDIX A**

GOALTENDER'S STICK, PLAYER'S STICK AND PUCK (Rule 3.3, 3.8)

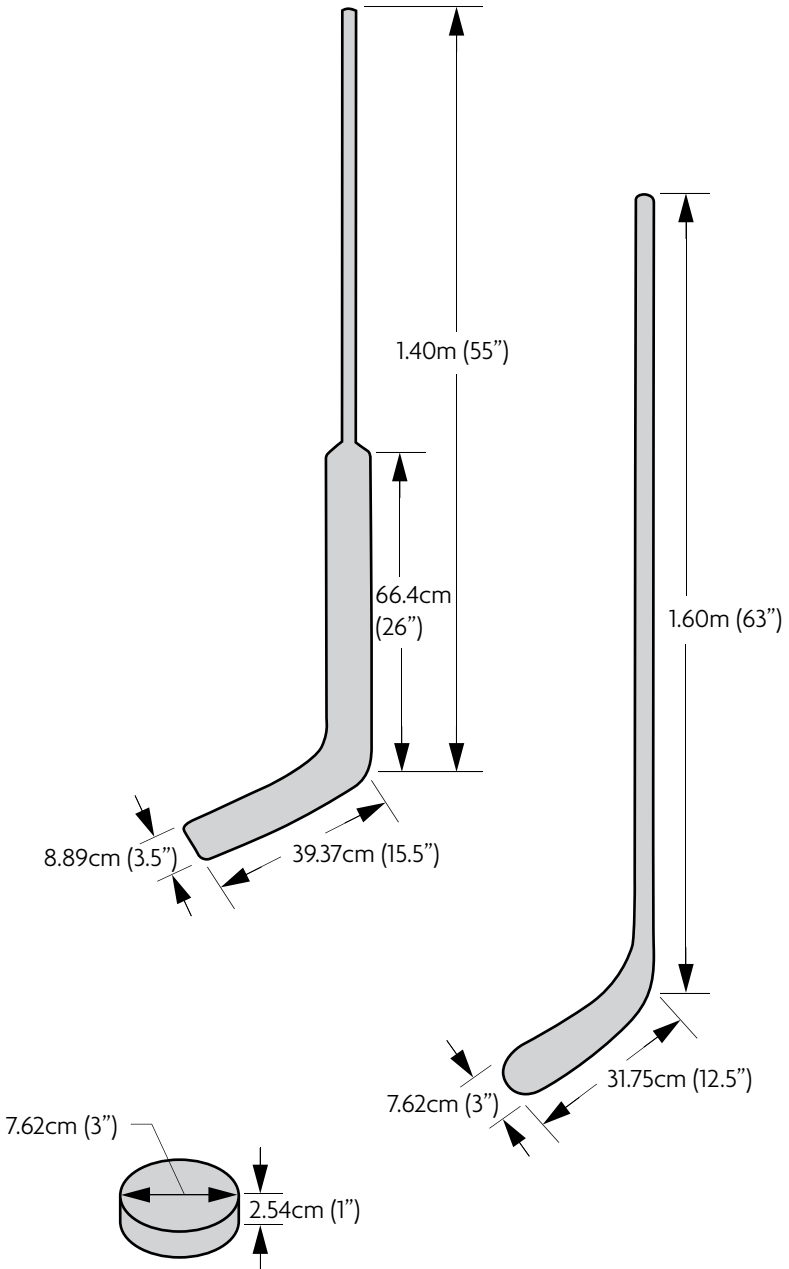



**APPENDIX B**

**GOALTENDER'S GLOVES AND PADS (Rule 3.5)**

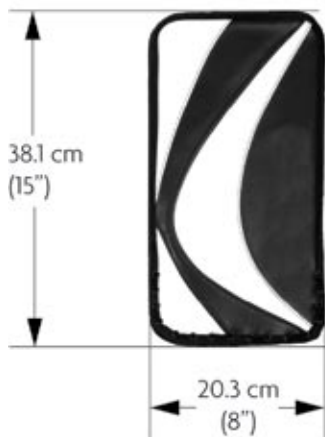

**APPENDIX C**

The Rink and Ice Markings

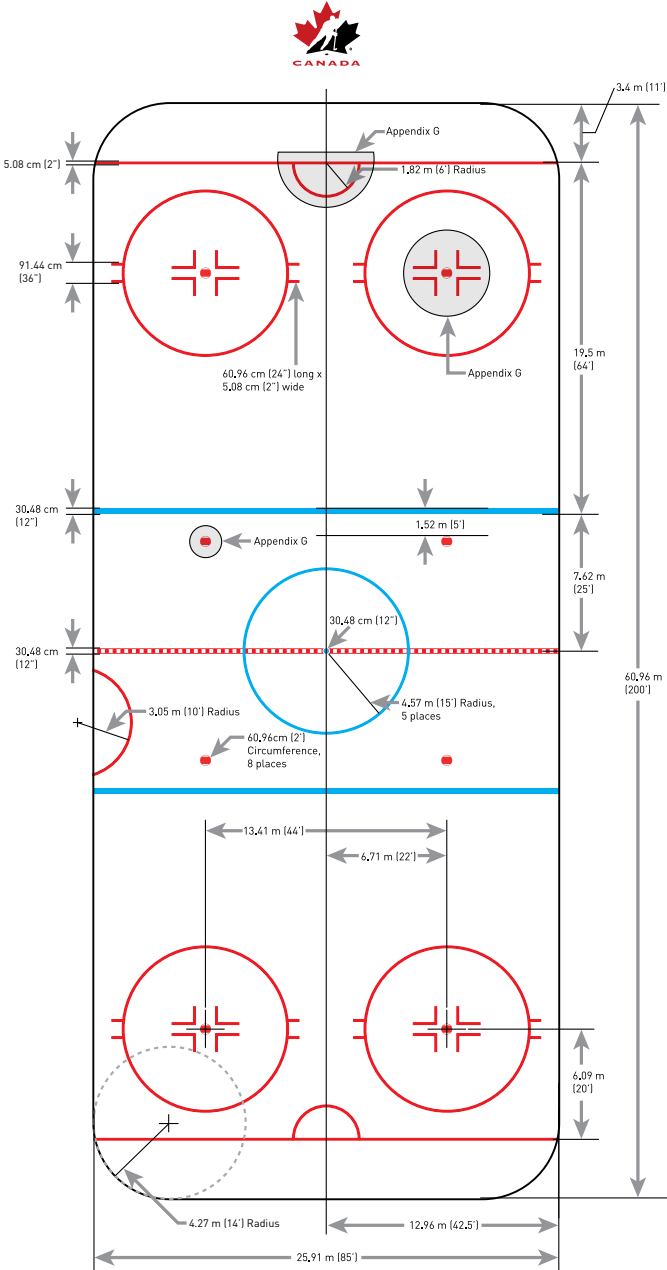

## APPENDIX D

## PENALTY OPTIONS CHART

This chart does not cover all penalty rules, but is designed to give the options available for the common penalty types.

Please refer to the text of the rules for all options.

Minor	Minor or Major + GM	Major + GM	Double Minor or Match	Minor + GM or Major + GM or Match	Minor + Misconduct or Major + GM or Match
Aggressor	Boarding	Any Infraction resulting in Note 1	Butt-Ending	Checking from Behind	Checking to the Head
	Body Checking				
	Charging	Charging goaltender within goal crease	Head-Butting		
	Cross-Check				
Instigator	Elbowing	Cross-Checking goaltender within goal crease	Spearing *		
	High Stick *				
	Holding				
Throwing Note 2	Hooking/Butt-End Hooking	Cross-Checking above normal height of opponent's shoulders			
	Interference				
	Kneeing				
	Pulling Hair/Grabbing Visor, Helmet, or Chinstrap				
Unsportsmanlike Conduct	Roughing / R.A.W.	Fighting			
	Slashing				
	Tripping				
Diving					

Note 1. A Match penalty shall be assessed for any deliberate attempt to injure and for any infraction that results in a deliberate injury.

Note 2. Throwing Stick: Misconduct penalty if thrown outside playing area. Penalty Shot if thrown by the defending player at the puck or puck carrier in the defending zone.

**APPENDIX E****INSTRUCTIONS TO OFF-ICE OFFICIALS**

Off-ice Officials are to be treated with courtesy at all times by players and team officials.

Off-ice Officials are under the general supervision of the Referee for the playing of each game.

Off-ice Officials should follow the instructions as stated in the Hockey Canada Rule Book with reference to Timekeepers, Official Scorer and Goal Judges. They will save themselves from many unpleasant incidents if these instructions are followed.

Off-ice Officials shall refrain from criticizing the work of any other official at any time. The Penalty Timekeeper should keep the Penalty Bench free of spectators; should there be any trouble in this respect, report the matter to the Referee.

Off-ice Officials should be at their respective positions a few minutes prior to the start of the game and subsequent periods.

When the Official Scorer obtains the team line-ups, he shall obtain the name and number of the Captain and Alternate Captain(s) of each team. This information shall be given to the Referee prior to the start of each game. If the Official Scorer encounters any difficulty in obtaining the team line-ups, he shall report this to the Referee.

Following the completion of the game the Official Scorer shall sign the Official Game Report and also see that it is signed by the Referee. The Report should then be sent to the appropriate Branch or League office.

**APPENDIX F****DUTIES OF TEAMS OR RINK MANAGERS RELATING TO RINK CONDITIONS:**

- To provide proper police protection at all times.
- To ensure proper magnetic or breakaway fastening devices are used.
- To provide well lighted and heated dressing rooms for the competing teams and Officials.
- To provide sanitary toilet and shower in each dressing room.
- To provide a suitable sound device for the use of the Game Timekeeper during the game.
- To reserve a bench for each team and a bench for the penalized players, Timekeepers and Official Scorer.
- To assist in having each game start on the advertised hour.
- To see that unauthorized persons are not allowed on the ice during the game.
- To be responsible for the proper markings of the ice surface according to Hockey Canada Rules. To keep the goal nets and goal lights in good order.
- To check and maintain the timing device in good working order.
- To, if possible, supply a doorman for the entrance to the Officials' dressing room.
- To make certain that first-aid kits and stretchers are available.

## APPENDIX G

## GOAL CREASE - (Rule 1.5)

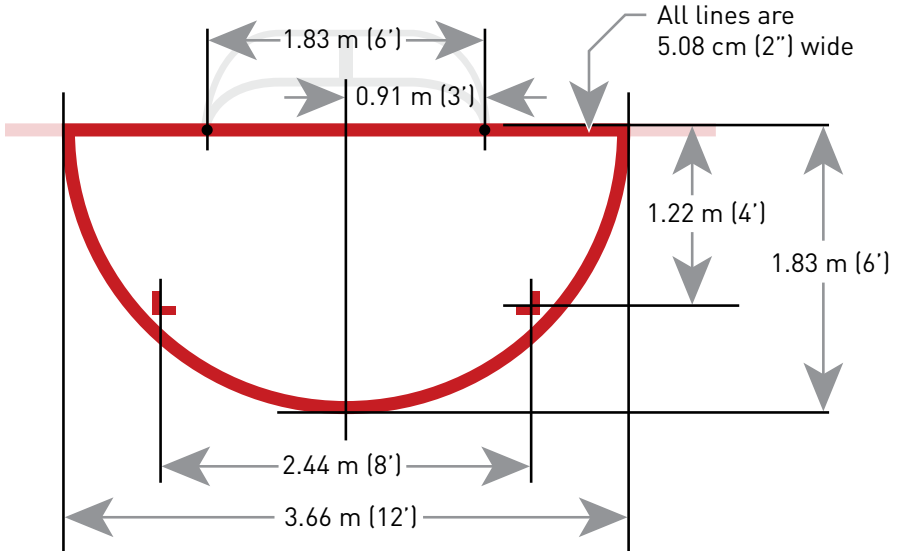

A semi-circle six feet 1.83m (6') in radius and two inches (5.08cm) (2") in width shall be drawn using the centre of the goal line as the centre point. In addition an "L"-shaped marking of five inches (12.7cm) (5") in length (both lines) at each front corner will be painted on the ice. The location of the "L"-shaped marking is measured by drawing an imaginary four foot (1.22m) (4') line from the goal line to the edge of the semi-circle.

## Goal Netting

There shall be attached to each goal frame a net of approved design made of white nylon cord which shall be draped in such manner as to prevent the puck coming to rest on the outside of it, yet strung in a manner that will keep the puck in the net.

A skirt of heavy white nylon fabric or heavyweight white canvas shall be laced around the base plate of the goal frame in such a way as to protect the net from being cut or broken. This skirt shall not project more than 2.54cm (one inch) above the base plate.

*Note: The frame of the goal shall be draped with a nylon mesh net so as to completely enclose the back of the frame. The net shall be made of three-ply twisted twine (0.33cm (0.130 inch) diameter) or equivalent braided twine of multi filament white nylon with an appropriate tensile strength of 318 kgs (700 pounds). The size of the mesh shall be 6.35cm (2 1/2 inches) (inside measurement) from each knot to each diagonal knot when fully stretched. Knotting shall be made as to ensure no sliding of the twine. The net shall be laced to the frame with medium white nylon cord no smaller in size than No. 21.*

**APPENDIX G**

Face-Off Restraining Lines

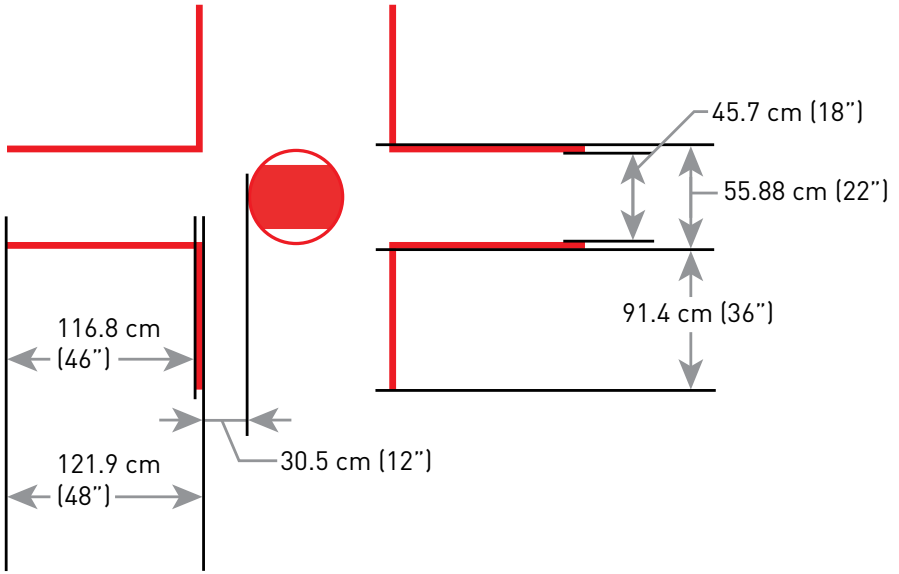

NEUTRAL AND END ZONE FACE-OFF SPOTS (Rule 1.7 and 1.8)

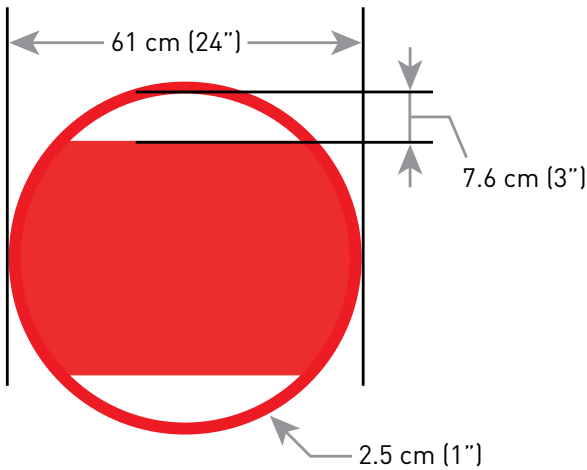

**CROSS REFERENCE**

This Cross Reference is designed to help you quickly locate various situations or specific rule applications. Consult rule for exact application.

**A**

Attacking player(s) entering attacking zone on gatherings . . . . .	10.2 (j)
Attacking players causing stoppage in attacking zone . . . . .	10.11 (c) Note
Awarded goal with goaltender on ice . . . . .	4.9 (b)

**B****Bench Minor Penalties**

· Team officials/players on bench . . . . .	1.9 (d)
· Change of players . . . . .	2.5 (e)(g)
· Injured players . . . . .	2.6 (e)
· Unsustained measurement . . . . .	Section Three
· Helmet on bench . . . . .	3.6 (b)(Note 4)
· Abuse by team official . . . . .	9.2 (b)
· Unidentified abuse . . . . .	9.2 (c)
· Banging stick . . . . .	9.2 (h)
· Delay of game . . . . .	10.1 (a)
· Failure to place correct number of players on ice . . . . .	10.1 (f)
· Objects thrown from bench . . . . .	7.3 (c)(d)
· Start of game and periods . . . . .	10.15 (e)
· End of periods . . . . .	10.15 (e)

**C****Centre Ice Face-offs**

· After a goal is scored . . . . .	10.4 (a), 10.15 (b)
· Error in calling icing . . . . .	10.5 (f)
· Premature substitution . . . . .	2.5 (f) Note 3
· Start of game and periods . . . . .	10.15 (b)
Checking goal nets . . . . .	5.2 (r)
Checking to the Head . . . . .	6.5
Choice of ends . . . . .	1.9 (e), 10.15 (c)
Closing hand on the puck . . . . .	9.1 (a)
Colour conflict with sweaters . . . . .	3.8 Note
Contact after the whistle . . . . .	4.1 (b) Note 2, 6.7 (g)

**D**

Delay of Game	
· Captain or alternate leaving players' bench . . . . .	2.4 (f)
· Player changes . . . . .	2.5 (e)
· Injured goaltender. . . . .	2.6 (b)
· Injured player . . . . .	2.6 (g)
· Adjustment of equipment . . . . .	3.1 (c)
· Goaltender going to players' bench . . . . .	3.2 (e)
· Goaltender removing helmet . . . . .	3.6 (c)
· Start of game and periods. . . . .	10.15 (d)
Delay with less than 5 minutes in 1st or 2nd period. . . . .	10.17 (e)
Deliberate illegal substitution . . . . .	2.5 (f)
Deliberately freezing the puck . . . . .	10.1 (a) Note 3, 9.1 (b), 10.10 (b)
Deliberately shooting puck away from official. . . . .	9.2 (b)(3)
Deliberately shooting puck out of bounds . . . . .	10.11 (b)
Disallowed Goals	
· Batted puck . . . . .	9.1 (e)
· Deflected puck off Referee or Linesman . . . . .	10.2 (i), 10.4 (e)
· High Stick. . . . .	8.2 (e)
· Ineligible player. . . . .	9.5 (g)(h)
· Kicked puck (directly or off goaltender) . . . . .	10.7
Dispute regarding time . . . . .	5.7(d)
Disputed goals . . . . .	5.2 (e)
Double Minors	
· But-ending or using shaft of stick . . . . .	6.1 (f)
· First to leave players' /penalty bench during fight . . . . .	9.5 (b)
· Grabbing hair, facemask, helmet or chin strap . . . . .	6.1 (d)
· Spearing (poke or jab) . . . . .	6.1 (g)

**E**

End of Period Procedure . . . . .	10.15 (e)
-----------------------------------	-----------

**F**

Face-off Locations	
· Delayed penalty - non-offending team causes stoppage . . . . .	4.13 (b)
· Premature substitution for goaltender . . . . .	2.5 (f)
· When play is stopped immediately when match penalty being assessed. . . . .	4.13 (d)
· Point players past top of circle. . . . .	10.2 (j)
· Disallowed Goals . . . . .	10.4 (h)
· Puck directed with glove . . . . .	9.1 (d)(e)
· Contacting puck with high stick. . . . .	8.2 (d)
· Error on icing call . . . . .	10.5 (f)
· Error on off-side pass call . . . . .	10.9 (e)
· Stoppage due to spectators . . . . .	10.6 (b)



**G**

Game Ejection - Stick Infractions . . . . .	4.2 (f), 4.6 (a)
Gathering . . . . .	10.2 (j)
Goaltender Situations	
• Charged in crease . . . . .	6.3 (b)
• Checked outside crease . . . . .	6.3 (b) Note, 7.3 (b) Note
• Cross checked in crease . . . . .	8.1 (c)
• Deliberately dislodging net . . . . .	4.9 (b), 4.10 (c), 10.1 (c)(d)
• Deliberately freezing the puck . . . . .	9.1 (b)
• Drop kicking puck . . . . .	4.11 (f)
• Going to players' bench . . . . .	3.1 (c), 3.2 (e)
• Interfered with or impeded . . . . .	6.3 (b), 7.3 (b)
• Leaving crease during a fight . . . . .	4.11 (c)
• Leaving crease to freeze puck . . . . .	10.2 (h), 10.3(b)
• Loss of helmet . . . . .	3.6 (c)
• Participating in play beyond centre red line . . . . .	4.11 (e)
• Penalties served by teammates . . . . .	4.11 (a)
• Premature substitution . . . . .	2.5 (f) Note 3
• Removal of facemask when requested by Referee . . . . .	3.5 (d)
• Shooting puck out of play. . . . .	10.1 (a)
• Snow or obstacles at or near net . . . . .	4.10 (c), 7.3 (f)
• Throwing puck forward. . . . .	9.1 (b) Note
• Throwing stick or object. . . . .	4.9 (b), 4.10 (a)(2), 9.8
• Using a players' stick. . . . .	3.2 (c)
• Wearing helmet and facemask on players' bench. . . . .	3.6 (b) Note 4

**H**

Hand Pass - Batted Puck . . . . .	9.1 (d)
Helmet worn in offset position . . . . .	3.6 (d)

**I**

Icing Procedures . . . . .	10.5 (a)
Illegal Equipment . . . . .	3.5 (c), 3.6 (e)(g)
Illegal Substitution . . . . .	2.5 (f)
Ineligible Player . . . . .	2.2 (b) 2, 9.5 (g)(h)
Instigator or aggressor penalty. . . . .	6.7 (a)(1)

**L**

Linesmen consulting with Referee . . . . .	5.3 (d)(e)
--	------------

**N**

Number of players required to start game . . . . .	2.2 (a)
--	---------

**O**

Overtime .....	10.16
----------------	-------

**P**

Penalized Player on Penalty Bench	
· Assessed a Bench Minor penalty .....	9.2 (h)
· Causes interference .....	7.3 (c)(d), 9.5 (e)
· Injured .....	2.6 (e)(f)
· Leaving penalty bench during a fight .....	9.5 (b)(c)
· Leaving penalty bench prematurely .....	9.5 (d)(g)
· Remaining in penalty bench .....	4.2 (b) Note, 4.2 (d)(e), 10.5 (a) Note 2
· Wearing helmet and facemask. ....	3.6 (b) Note 4
Penalty Shot infractions	
· Calling for a Major or Match penalty .....	4.9 (h)
· Dislodging net .....	10.1 (d)
· Falling on, holding, gathering into body, or picking up puck while puck is in crease .....	10.3 (c), 9.1 (c)
· Interference by player or team official. ....	9.5 (e)
· Last two minutes of regular playing time .....	10.1 (e)
1) Deliberate Illegal Substitution .....	2.5 (f)
2) Deliberate knocking of net from its position. ....	10.1 (c)
3) Removal of Protective Equipment .....	3.6 (c)
4) Refusing to start play .....	10.14 (a)
· Throwing stick .....	9.8 (a)
· Tripped or fouled from behind .....	7.4 (d)
Physical abuse towards officials .....	9.6
Player loosing helmet .....	3.6 (c)
Player(s) leaving players' bench to discuss rules or deliver instructions .....	2.4 (f), 10.1 (b)
Players on ice to start periods .....	10.15 (d)
Players remaining on benches at end of period .....	10.15 (e)
Players retiring to their benches during a fight .....	6.7 (a)(5)
Pre-game warm-up .....	2.2 (g)(h)
Premature substitution .....	2.5 (f) Note 3

**R**

Refusing to designate a player to serve penalty .....	4.1 (c)
Refusing to leave bench or playing area. ....	10.14 (e)

**S**

Slew Footing .....	7.4 (b)
Stick infractions - game ejection .....	4.2 (f)
Stick Measurement	
· Before penalty shot. ....	4.9 (i)
Suspended Players .....	1.9 (c), 2.2 (h)

**T**

Team Officials . . . . .	1.9 (e)
Throwing Stick or Object	
· From players/penalty bench . . . . .	7.3 (c)(d)
· On the ice. . . . .	4.10 (a)(2), 9.8 (a)(b)
· Outside playing area . . . . .	9.8 (d)
Time-outs . . . . .	10.17 (f)
Two or more pucks on ice . . . . .	10.12 (b)

**U**

Unidentified person committing an infraction . . . . .	4.3 (b), 9.2 (c)
Unsportsmanlike conduct . . . . .	9.2 (a)(j)

**V**

Visiting Team	
· First to leave ice . . . . .	10.15 (e)
· First to place playing line-up on ice . . . . .	2.5 (d)(g)
· First to place stick down on face-offs. . . . .	10.2 (a)
· First to take position on penalty bench . . . . .	4.1 (d)

**W**

Wearing helmet and facemask on players' bench . . . . .	3.6 (b) Note 4
---	----------------



**Yelling at the  
refs will help  
your team win.**

**'Cause they really  
like that.**

(Do ya think?)

We lose **10,000** officials every year. Are you the cause?

**HOCKEY CANADA'S OFFICIATING PROGRAM**

Visit [HockeyCanada.ca/officials](http://HockeyCanada.ca/officials) to learn more about respect of officials and how you can get involved in officiating.

**[HockeyCanada.ca/officials](http://HockeyCanada.ca/officials)**





***BAUER***

***SUPREME***  
**TOTALONE**

**THETOTALONE.COM**

# **FORCE**

*Always the  
right call!*

**Approved by  
Hockey Canada**



**CANADA**

**Available at over 300  
Authorized Dealers**

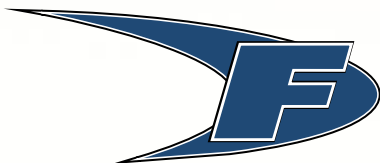

[forcesports.com](http://forcesports.com)

**HOCKEY**  **CANADA**



**HOCKEY CANADA** - Calgary  
2424 University Dr. NW, Calgary, AB T2N 3Y9

**HOCKEY CANADA** - Ottawa  
801 King Edward Ave., Suite N204, Ottawa, ON K1N 6N5

